

REEBOT

New-Era Mini Quad-Sensor Optical AI Pod UniPod MT11 User Manual

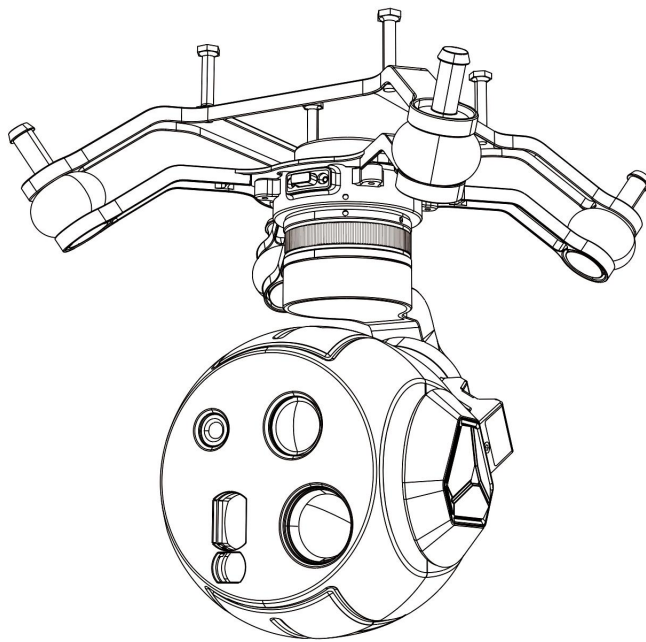

REEBOT

Thank you for purchasing a Reebot Robotics product.

The UniPod MT11 is an advanced mini quad-sensor AI optical pod featuring a wide-angle camera, zoom camera, thermal imager, and laser rangefinder. It supports 8K RAW photography at 48 MP and integrates a built-in 10 TOPS AI processor for on-board object recognition, tracking, and AI super-resolution — no external AI module required.





Weighing only 405 g (45% lighter, 63% smaller than the first generation) and with a spherical design supporting 140 km/h maximum airspeed, the MT11 is optimized for multirotor and VTOL UAV applications in inspection, security, and mapping.

For safe and efficient operation, please read this manual before installation. Visit www.reebot.com, call +86 400-097-0971, or email info@reebot.com for technical support and feedback.

REEBOT

Contact Reebot:

Official Website: <https://reebot.com/en/>

Official website	
Facebook	
X	
YouTube	

REEBOT

Manual Version Update Record

Version Number	Update Date	Update Content
V1.0	2025.8.8	Initial version.
V1.1	2025.11.11	Updated technical parameters and added UART control parameter settings.
V1.2	2025.12.31	Added calculation formula for raw thermal temperature data; technical parameters updated.
V2.0	2026.6.4	Added instructions for AI Follow Mode, Double-Tap Targeting, Multi-Country License Plate Recognition, and AI Recognition Push.

Contents

Reading Instructions	7
Chapter 1: Product Overview	12
1.1 Key Features	12
1.2 Interfaces and Definitions	15
1.3 Technical Specifications	17
1.4 Package Contents	21
1.5 Status Indicator Definitions	23
Chapter 2: Before Use	24
2.1 Installation and Mounting	24
2.2 Connection and Power Supply	24
2.3 Usage Recommendations and Precautions	26
Chapter 3: Highlighted Features	27
3.1 Dual Visible-Light Camera System with Dual 8K Capture	27
3.2 Next-Generation Focusing Algorithm	27
3.3 Up to 10T AI Computing Power	29
3.3.1 Intelligent AI Recognition and Tracking	29
3.3.2 Custom AI Models	29
3.3.3 Region Selection Tracking	30
3.3.4 AI Recognition Push & Multi-Country License Plate Recognition	30
3.4 EIS Video Stabilization	32
3.5 ISP Parameter Adjustment	33
3.6 Modify IP Address	36
3.6.1 Online IP Address Modification	36
3.6.2 IP Address Scanning (Within the Same Subnet)	37
3.6.3 If the Modified IP Is Forgotten	38
3.7 Electronic Dehaze	39
3.8 Night Vision Mode	40
3.9 Double-Tap Targeting	40
Chapter 4: Gimbal Control	42
4.1 Controlling the Gimbal via UniGCS APP on the Link Device	42
4.1.1 Gimbal Rotation Control and One-Touch Rotation	42
4.1.2 Photo Capture Control	43
4.1.3 Video Recording Control	45
4.1.4 Photo and Video File Name Conventions	46
4.1.5 Zoom Control	47
4.2 UniGCS APP Channel Configuration for Controlling the Gimbal via S.BUS Signal Forwarding	48
4.2.1 Cable Connection	48
4.2.2 Camera Control	49
4.2.3 Gimbal Control	50
4.3 Integrating Flight Controller Data	51

REEBOT

4.4 Controlling the Gimbal Camera via UART with ArduPilot	52
4.4.1 Controlling Gimbal Attitude and Camera Functions via MAVLink Protocol	53
4.4.2 Controlling Gimbal and Camera Functions via proprietary Protocol	55
4.5 AI Follow Mode	56
Chapter 5: Video Output	60
5.1 Video Output via UniGCS APP	60
5.2 Video Output via Direct Ethernet Connection to Windows Device (e.g., PotPlayer)	62
5.3 EasyPlayer Four-Stream Playback	63
5.4 Common Device Stream Addresses	63
5.5 Troubleshooting Video Output Issues	64
Chapter 6: Laser Rangefinder	68
Chapter 7: Thermal Imaging	70
7.1 Thermal Imaging Temperature Measurement	70
7.1.1 Point Measurement	70
7.1.2 Box Measurement	71
7.1.3 Full-Image Measurement	72
7.2 Thermal Imaging Environmental Calibration	73
7.3 Pseudo-Color Mode Settings	77
7.4 Thermal Imaging AI Super-Resolution	83
7.5 Thermal Imaging Gain	84
7.6 Thermal Imaging Raw Data	84
Chapter 8: UniGCS APP	85
8.1 UniGCS APP Main Interface Overview	85
8.2 Function List Overview	87
Chapter 9: MT11 Firmware Upgrade and Accelerometer Calibration	92
If the device fails to display video or encounters any abnormal conditions during the upgrade, please retry the upgrade. If the issue persists, restart the device and check whether it returns to normal or attempt the upgrade again.	96
If the problem remains unresolved after these steps, please contact official technical support and provide details of the previous operations for troubleshooting.	96
Chapter 10: After-Sale Policy	97
10.1 Scope of Application	97
10.2 Return Service	97
10.2.1 Timeframe and Conditions	97
10.2.2 Situations Not Eligible for Return	97
10.3 Exchange Service	98
10.3.1 Timeframe and Conditions	98
10.3.2 Situations Not Eligible for Exchange	99
10.4 Warranty Service	99
10.4.1 Warranty Period and Conditions	99
10.4.2 Warranty Start Date	100
10.4.3 Warranty Period	100
10.4.4 Situations Not Covered by Warranty	100
10.5 General After-Sales Terms	101

REEBOT

10.5.1 Repair Locations and Methods	101
10.5.2 Software Services	102
10.5.3 Data Privacy and Security	102
10.5.4 Shipping Costs	102
10.5.5 Other Fees	103
10.5.6 Other After-Sales Notes	103

Reading Instructions

Logo, icon

When reading the user manual, please pay special attention to the relevant contents marked as follows



Danger – Indicates a hazardous situation which, if not avoided, will result in serious injury or death



Warning – Indicates a potentially hazardous situation which, if not avoided, could result in serious injury.



Caution – Indicates a situation which, if not avoided, may result in property damage.



Prohibited Actions



Mandatory Actions



Precautions

Security

The UniPod MT11 Mini Quad-Sensor AI Optical Pod is designed and manufactured for professional applications. All necessary calibration and testing have been completed prior to shipment. Do not disassemble the optical pod, modify its

REEBOT

mechanical structure, or add any additional payloads to the optical pod. The UniPod MT11 features a precision mechanical structure and must be operated by personnel with basic technical knowledge. Handle the device with care at all times.

Any damage, property loss, personal injury, or third-party harm caused by improper, unauthorized, or irresponsible operation of this product is the sole responsibility of the user. Reebot Robotics assumes no liability for such incidents. When operated by minors, professional supervision is required at all times.

Reebot products are designed for commercial and civilian applications only. Use of Reebot products for military purposes is strictly prohibited. Disassembly, modification, or unauthorized alteration of this product without prior approval from Reebot Robotics is strictly forbidden.

 Do not use SIYI ZT30 or ZR30 Quick Release Anti-Vibration Board to install the UniPod MT11.

 Do not point the infrared camera lens at high-energy sources such as the sun, molten lava, or laser beams.

 Do not power the device with a power supply exceeding the operating voltage range.

 After use, store the device in the UniPod MT11 Storage Case with desiccant to avoid lens fogging.

 Ensure that the dock interface and gimbal connector are completely dry before installing the gimbal.

REEBOT

 Do not insert or remove the TF card while powered on, and do not install or remove the UniPod MT11 under power.

 Do not place the UniPod MT11 in direct sunlight, poorly ventilated, or damp environments, or near heat sources such as heaters or radiators.

 Avoid frequent power cycling. After shutdown, wait at least 30 seconds before restarting to prevent damage to the camera module.

 Handle with care during storage and transport. Do not drop or impact the device, as this may cause malfunction.

 The power supply or external power source must support at least 5 A overcurrent capacity.

 Achieves IP54 rating under IEC 60529 in controlled laboratory conditions; not permanent and may degrade with wear.

Attention

Please do not forcefully install the UniPod MT11 unit onto the old Quick Release Anti-Vibration Boards (such as those of the ZR30 and ZT30); this will pose a significant risk of product damage.

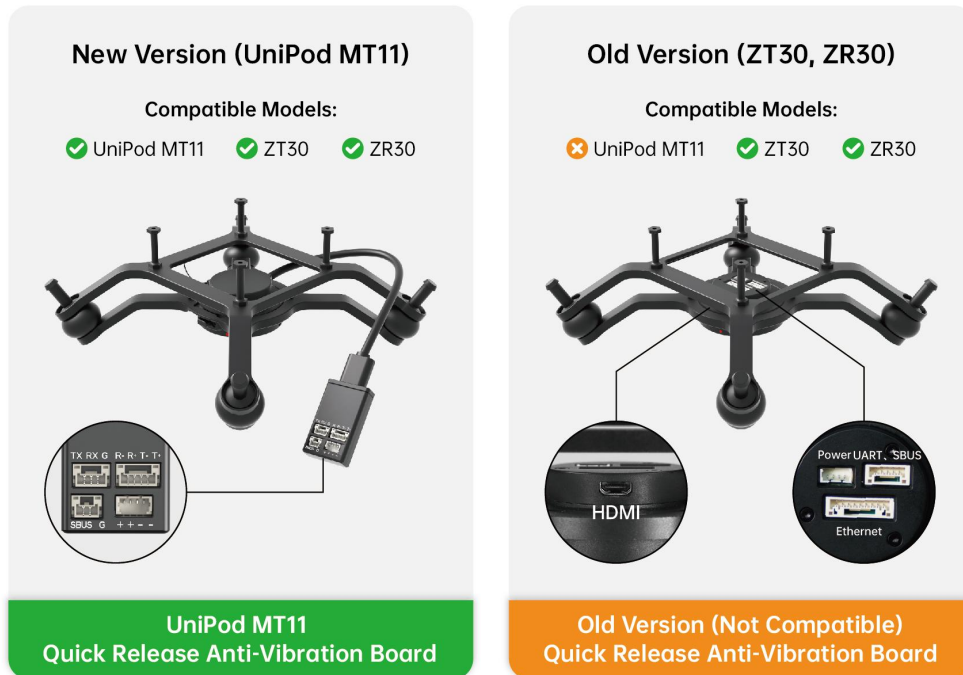

Please do not install the UniPod MT11 onto the old version quick release anti-vibration board!

 When using the ZT30 or ZR30 gimbal with the MT11 quick-release mount, note that their initial orientations differ. The ZT30 and ZR30 gimbals are offset by 90° from the MT11's default starting position.

Storage, Transport, and Disposal

When your Reebot product is not in use or is being transported for field operations, please observe the following precautions:

 **Danger**

Keep the product out of reach of children when not in use.

Do not store the product in extreme temperatures, above 60 °C or below -20 °C.

REEBOT

 **Caution**

Avoid exposure to moisture, humidity, or dusty environments.

During transport or handling, avoid vibration, drops, or impacts that may damage internal components.

Chapter 1: Product Overview

The UniPod MT11 (hereinafter referred to as “MT11”) is a professional mini quad-sensor AI gimbal pod integrating a wide-angle camera, zoom camera, thermal imaging camera, and laser rangefinder, suitable for various application scenarios.

The wide-angle camera of the MT11 mini quad-sensor AI gimbal pod features an 84° field of view, providing excellent coverage. Both the wide-angle and zoom cameras support 8K photography and 4K video recording. The zoom camera is equipped with 11× optical zoom and Electronic Image Stabilization (EIS), enabling longer, clearer, and more stable observation.

1.1 Key Features

Integrated Quad-Sensor System – Powerful and Versatile

The UniPod MT11 mini quad-sensor AI gimbal pod adopts an industry-leading hybrid sensor solution, integrating a wide-angle camera, zoom camera, thermal imaging camera, and laser rangefinder for highly efficient collaboration. This enables UAVs to achieve a broad field of view, capture clearer images with zoom focus, detect heat sources, and measure target distance.

Professional UAV Imaging System

The MT11 features both a wide-angle camera and a zoom camera, each equipped with a 1/2" CMOS sensor with 48 MP effective pixels. Still images can be captured at up to

REEBOT

8K resolution (8000 × 6000), while video recording supports up to 4K resolution (3840 × 2160).

High-Resolution Thermal Imaging Camera: The thermal camera offers a resolution of 640 × 512 and supports AI super-resolution to enhance image quality (photo resolution supports 2× and 4× AI super-resolution; video resolution support 2× AI super-resolution). The thermal camera provides 8× digital zoom and supports synchronized zoom with the zoom camera. This allows two different views of the same scene to be displayed simultaneously, enabling operators to capture more details and quickly extract valuable information through comparative analysis.

High-Precision Laser Rangefinder: The MT11 is equipped with a high-precision laser rangefinder with an accuracy of ± 1 m and a measurement range of 5 - 1200 m.

High-Precision 3-Axis Mechanical Gimbal Stabilization with EIS Enhancement

The MT11 is equipped with a high-precision 3-axis stabilized gimbal (yaw, pitch, roll) . This ensures smooth video performance even during high-speed flight, turbulence, or complex terrain operations. The MT11 camera further supports Electronic Image Stabilization (EIS), providing enhanced image stability at high magnification levels.

AI-Powered Intelligent Recognition and Tracking

The MT11 integrates a built-in 10 TOPS AI computing unit, eliminating the need for an external AI module. With 10 TOPS of processing power, the system delivers faster

REEBOT

and more accurate recognition, adapting seamlessly to complex operational environments.

The platform supports multi-model switching, enabling diverse object recognition across visible light, thermal imaging, insulator inspection, and region-of-interest selection. When AI recognition is enabled, objects of interest are highlighted with a white bounding box. By selecting the bounding box, operators can activate AI-powered intelligent tracking for real-time target monitoring and acquisition.

Unlimited Yaw-Axis Rotation and High-Compatibility Quick Release Anti-Vibration Board

The MT11 supports unlimited yaw-axis rotation. Whether mounted on multirotor UAVs, VTOL fixed-wing UAVs, unmanned ground vehicles, or robotic platforms, the gimbal compensates for carrier yaw limitations, ensuring the camera remains locked on target without frequent platform adjustments.

The quick release anti-vibration board is designed for rapid installation and removal without the need for complex tools, significantly reducing deployment time. With strong compatibility, the mount not only supports the MT11 but is also backward compatible with the SIYI ZT30 and ZR30 optical pods.



Note: The quick release anti-vibration board of the ZT30 and ZR30 optical pods are not compatible with the MT11.

REEBOT

Multiple Gimbal Operating Modes for Greater Adaptability

√ **Upright Mode:** When mounted on a UAV, the gimbal automatically enters upright Mode when powered on (quick release anti-vibration board positioned on top of the gimbal body).

√ **Upside Mode:** When the gimbal is mounted upside down, it automatically enters Upside Mode (quick release anti-vibration board positioned beneath the gimbal body), suitable for installation on UGVs, USVs, robots, quadruped robots, and other platforms.

√ **Nose Mode:** When the gimbal is installed at a 90° angle relative to the horizontal plane, it automatically enters Nose Mode, ideal for mounting on the nose of VTOL fixed-wing UAVs to achieve a more convenient installation angle and a wider field of view.



Note: Lock Mode and AI Tracking are not supported in Nose Mode.

1.2 Interfaces and Definitions

Type-C Male Connector (for Expansion Dock) Pin Definition

Unit: mm

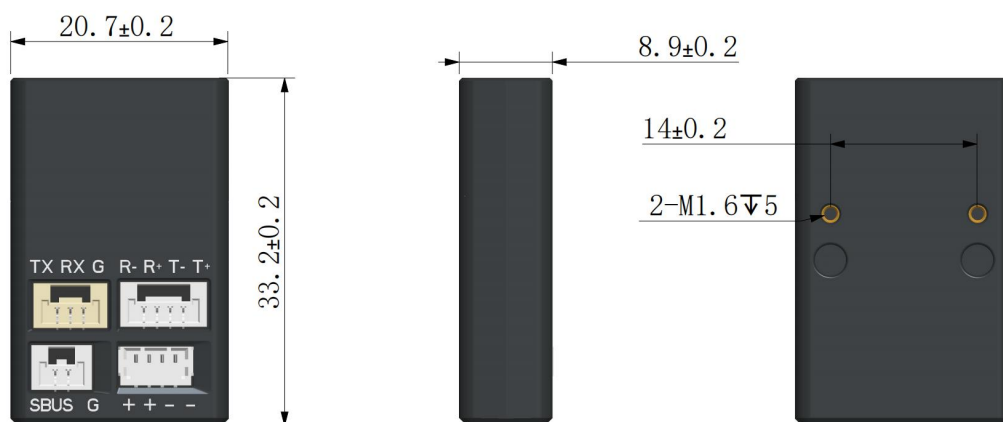

REEBOT

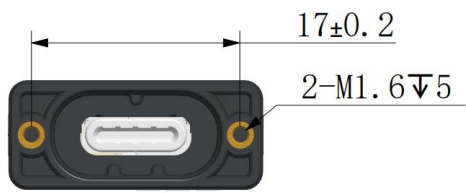

Type-C Female Interface Diagram

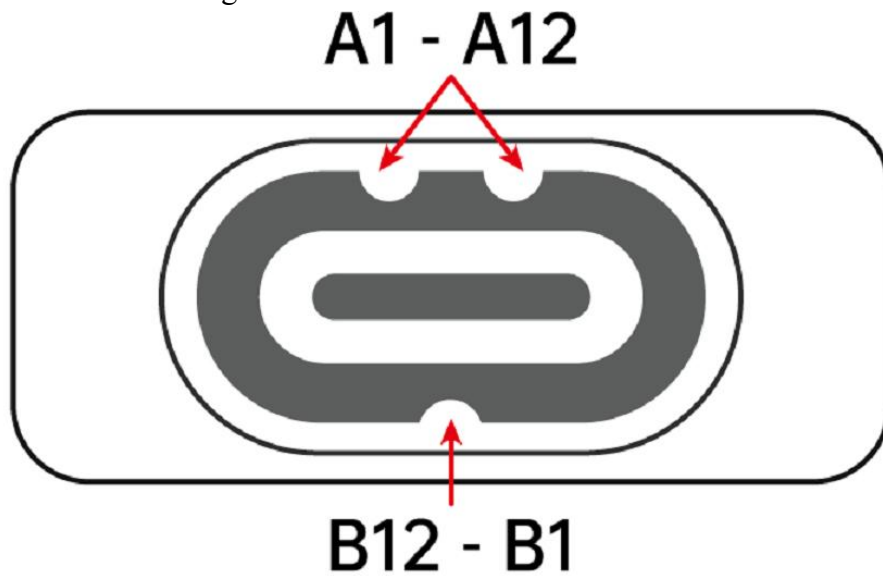

No.	A12	A11	A10	A9	A8	A7	A6	A5	A4	A3	A2	A1
Function	GND	RX+	RX-	VBUS	TX	/	/	RX	VBUS	TX-	TX+	GND
No.	B1	B2	B3	B4	B5	B6	B7	B8	B9	B10	B11	B12
Function	GND	/	/	VBUS	S.BUS	/	/	/	VBUS	/	/	GND

! The power supply or external power source must support at least 5 A overcurrent capacity.

1.3 Technical Specifications

General Specifications	
Dimensions	141.5 × 141.5 × 169 mm (Without the Quick Release Anti-Vibration Board)
	90 × 102.5 × 128 mm (With the Quick Release Anti-Vibration Board)
Weight	533.5 g ± 5 g (With the Quick Release Anti-Vibration Board and Interface Docking Station)
	405 g ± 5 g (Without the Quick Release Anti-Vibration Board)
System Power Consumption	Avg. 11.4 W (26V Power Supply, Static)
IP Level	IP54 Under controlled laboratory conditions, the product meets the IP54 protection rating as defined by IEC 60529. Note: This rating is not permanent, and protection performance may degrade over time due to product wear and usage.
Working Environment	-20 °C to 50 °C
Storage Temperature	-20 °C to 60 °C
Extreme Airspeed	140 km/h (Lab Data)
Cruising Airspeed	120 km/h (Lab Data)
Control Interface Protocols	S.Bus, UART, Ethernet (TCP/UDP)
Video Output	Ethernet Port
Operating Voltage	10–26 V (3–6S) *Requires independent power supply
Camera ISP Parameter Adjustment	Brightness: 0–100; Saturation: 0–100; Contrast: 0–100; Exposure Compensation (EV): ±10; Shutter Speed (SS); White Balance (WB);

REEBOT

	ISO Sensitivity
Optical zoom	11 x
Hybrid zoom	165 x
AI Computing Power	10 T
Gimbal Specifications	
3-Axis Stabilization System	Yaw, Pitch, Roll
Angular Jitter	0.01°
Installation Method	Quick-Release Anti-Vibration Board
Control Angle	Pitch: - 90° to +20° Yaw: 360° × N (Unlimited)
Structural Limit	Roll: - 60° to +60° Pitch: - 120° to +60°
Operation Mode	Follow Mode, FPV Mode, Lock Mode
Wide angle Camera Specifications	
Image Sensor	1/2" CMOS; Effective Resolution: 48 MP
Lens	Focal Length: 4.5 mm (Effective focal distance: 24 mm) Aperture: f/2.8
FOV	DFOV: 84°
Video Resolution	3840 × 2160 @ 30 fps 2560 × 1440 @ 30 fps 1920 × 1080 @ 30 fps 1280 × 720 @ 30 fps
Video Format	MP4
Video Encoding	H.265
Photo Resolution	3840 × 2160 8000 × 6000
Photo Format	JPG

REEBOT

Metering Modes	Avg / CW / Spot
Zoom Camera Specifications	
Image Sensor	1/2" CMOS; Effective Resolution: 48 MP
Lens	Focal Length: 15–50 mm (Effective focal distance: 81–270 mm) ± 5% Aperture: f/3.8–f/4.4
FOV	Wide: 28.98 (D) 23.48 (H) 17.81 (V) Tele: 9.06 (D) 7.29 (H) 5.49 (V)
Focus Modes	MF, AFS
Video Resolution	3840 × 2160 @ 30fps 2560 × 1440 @ 30fps 1920 × 1080 @ 30fps 1280 × 720 @ 30fps
Video Format	MP4
Video Encoding	H.265
Photo Resolution	3840 × 2160 8000 × 6000
Photo Format	JPG
Metering Modes	Avg / CW / Spot
Laser Rangefinder Specifications	
Wavelength	905 nm
Measuring Range(Building)	5–1200 m
Measurement Accuracy	± 1 m
Pulse Repetition Frequency (PRF)	3 Hz (5–45 m) 0.75–3 Hz (45–1200 m)
Eye Safety Classification	Class 3R
Infrared Camera Specifications	
Thermal Imaging Sensor	VOx Uncooled Pixel Pitch: 12 um

REEBOT

Lens	Focal Length: 18 mm Aperture: f/1.1
FOV	DFOV: 31°
Digital Zoom	8 x
Video Resolution	640 × 512 1280 × 1024 @ AI
Video Format	MP4
Video Encoding	H.265
Photo Resolution	640 × 512 1280 × 1024 @ AI 2560 × 2048 @ AI
Photo Format	JPG
NETD	≤50 mK @ 25 °C, F#1.0
Wavelength	8 - 14 μm
Temperature Measurement Accuracy	High gain: -20 °C to +150 °C (±2°C or ± 2%, Take max value) Low gain: 0 °C to +550 °C (± 3 °C or ± 3 %, Take max value)
High-Temperature Alarm	Supported
Temperature Measurement Mode	Full-Image / Point / Box Measurement
Pseudo-Color Modes	White Hot, Sepia, Iron, Night, Aurora, Red Hot, Medical, Black Hot, Glory Hot (9 modes total)
Additional Specifications	
Network Streaming Protocol	RTSP (primary + secondary dual-stream supported)
Stream Encoding Format	H.265、H.264
Stream Display	Frame stitching & view selection supported
Storage Card Format	FAT32 / exFAT *Please use U3/Class 10/V30 or higher-grade memory card

REEBOT

Video Recording Bitrate	4K: 40 Mbps 2K: 20 Mbps 1080P: 10 Mbps 720P: 5 Mbps (H.265)
Quick-Release Anti-Vibration Board Specifications	
Dimensions	141.5 × 41.5 × 63 mm
Weight	123 g ± 5 g (Without expansion dock)

1.4 Package Contents

Package Contents

Package Dimensions: L285 * W238 * H127 mm

Package Weight: 1578 g



UniPod MT11 Storage Case
x1



UniPod MT11 Unit
x1



UniPod MT11 Quick Release
Anti-Vibration Board &
Interface Docking Station
x1



UniPod MT11 Ethernet Port
to Crystal Head
x1



UniPod MT11 Ethernet Cable
x1



UniPod MT11
S.Bus Y-Splitter Cable
x1



3PIN N7 Autopilot to Gimbal
UART Cable
x1



Ardupilot / PX4 Flight
Controller UART to Gimbal
UART Cable
x1



UniPod MT11 Power
Input Cable
x1



Hex Socket Flat Head
Machine Screw TM3*8
x4

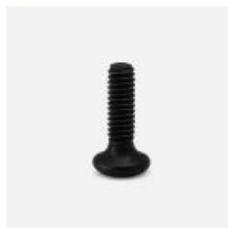

M1.6*5 Pan
Head Machine Screw
x4

REEBOT

1 × MT11 Unit

1 × MT11 Quick Release Anti-Vibration Board

1 × MT11 Storage Case

1 × MT11 Interface Docking Station

1 × MT11 Power Input Cable (MX1.25 4P to XT-30 Male Connector with Female Housing – for independent power supply to the gimbal pod)

1 × MT11 Ethernet Cable (GH1.25-4P to 8P Cable – for video transmission; 4P end connects to the expansion dock, 8P end connects to the third-party video transmission port)

1 × MT11 Ethernet to RJ45 Cable (GH1.25-4P to RJ45 Connector, for video transmission)

1 × Ardupilot / PX4 Flight Controller UART to Gimbal UART Cable (GH1.25-3P to 6P Cable – for gimbal-to-flight controller communication)

1 × 3PIN N7 Autopilot to Gimbal UART Cable (GH1.25-3P to GH1.25-3P Cable – for gimbal-to-flight controller communication)

1 × MT11 S.Bus Y-Splitter Cable (used to connect the MT11 gimbal to open-source flight controllers and third-party S.BUS interfaces, enabling simultaneous control of both the flight controller and the gimbal via the remote controller's S.BUS signal)







1 × Cable Storage Box (for organizing and storing cables)

1 × Screw Pack (includes 4 × M1.6×5 round-head machine screws for securing the expansion dock, and 4 × TM3×8 hex socket flat-head machine screws for securing the quick-release mount)

REEBOT

1.5 Status Indicator Definitions

The status indicator uses different colors and flashing patterns to display the gimbal's operating status and error conditions.

-  Solid Green: System operating normally
-  Slow Flashing Green: S.BUS signal input detected and functioning properly
-  Double Green Flash: Flight controller attitude data successfully fused
-  Flashing Red: Firmware mismatch (camera firmware or gimbal firmware)
-  Red-Red-Yellow Sequence Flash: Camera board not recognized
-  Rapid flashing: System upgrading

REEBOT

Chapter 2: Before Use

2.1 Installation and Mounting

Screw Hole Positions and Spacing

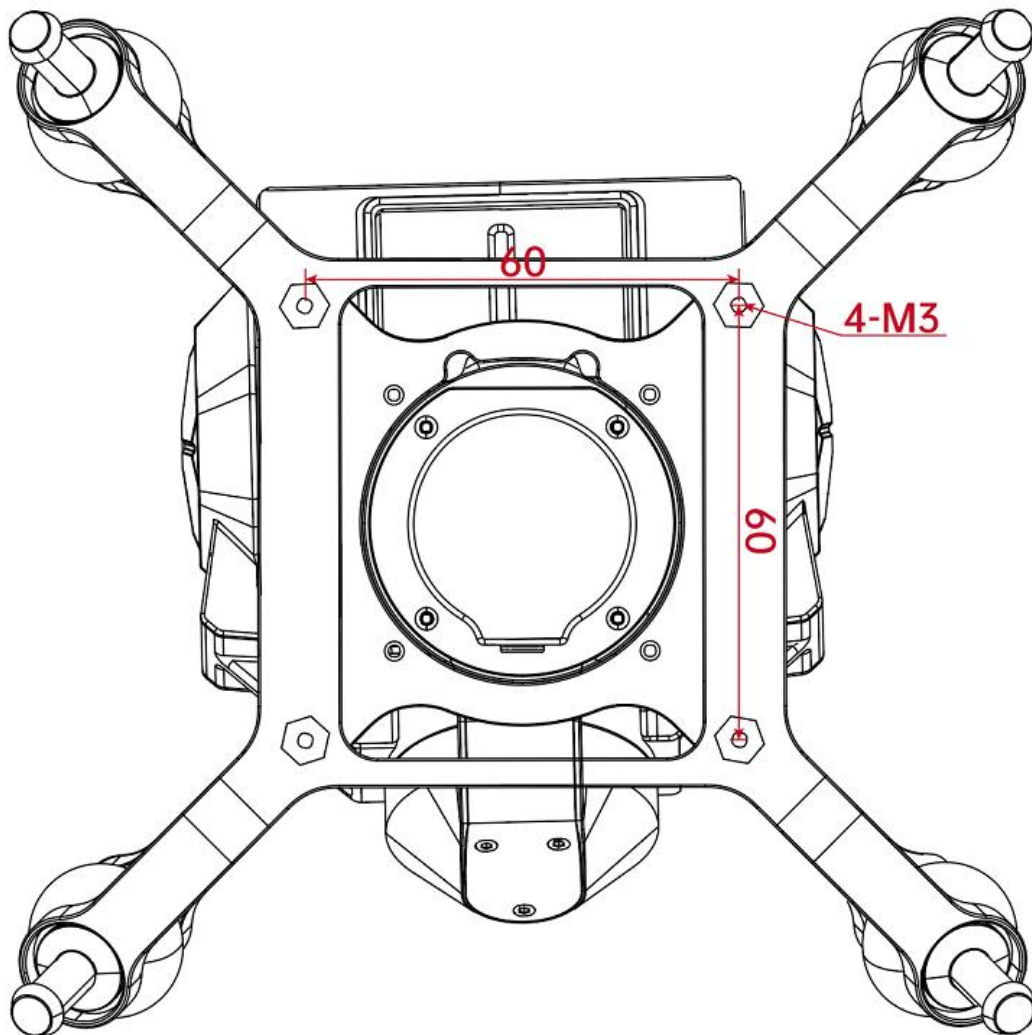

2.2 Connection and Power Supply

Expansion dock interface definitions are shown in the diagram below:

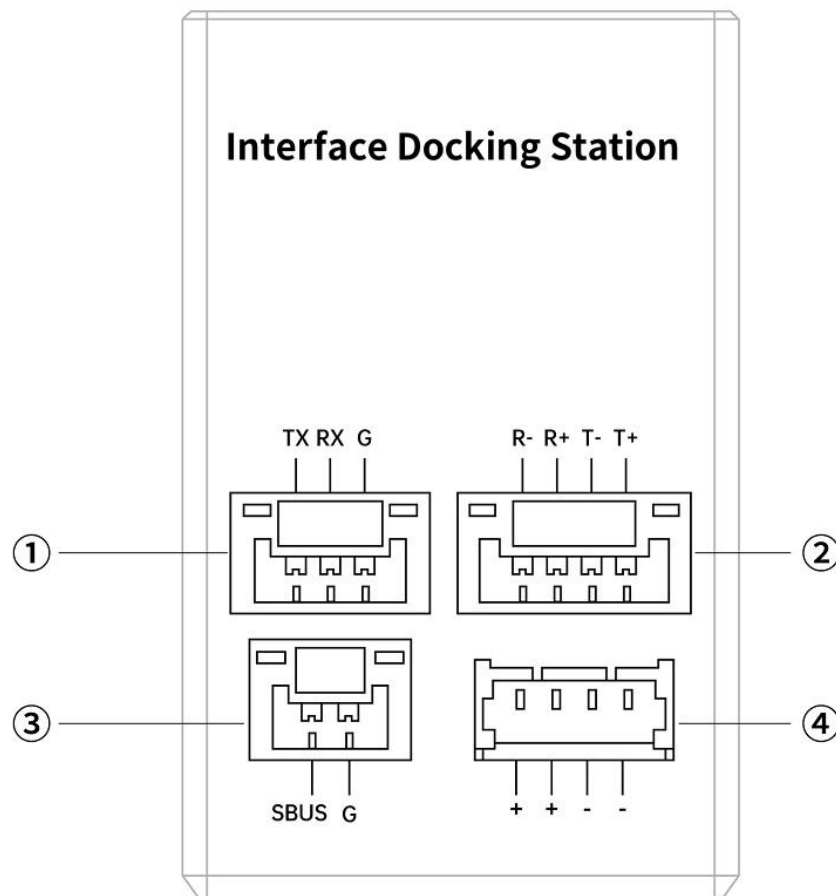

Interface Definitions and Functions

- ① Gimbal UART Port – Connect to the flight controller TELEM port. After configuring the flight controller parameters, flight control data can be fused.
(TX → FC RX, RX → FC TX)
- ② Gimbal LAN Port – Connect to the air unit LAN port or directly to a computer.
- ③ Gimbal S.BUS Input Port – Connect to the air unit S.BUS port to configure remote controller channels, enabling gimbal control via the remote controller.
- ④ Power Input Port – MX1.25 4P to XT-30 male connector; requires independent power supply, operating voltage 10–26 V.

REEBOT

2.3 Usage Recommendations and Precautions

Usage Recommendations

Always use the standard Quick-Release Anti-Vibration Board and secure it to the vehicle using the four M3 screws. Ensure the mounting surface is flat to avoid additional load that may compromise damping performance.

Before installation, inspect the damping balls for damage or aging. Replace any worn or damaged components promptly to ensure gimbal stabilization performance.



Precautions

Avoid severe impacts, drops, or vibrations. During transport, always use the provided storage case to protect precision components such as the gimbal motors and lenses.

Keep lenses (visible, infrared, and laser windows) clean. If dust or smudges appear, gently wipe with a dedicated lens cloth. Do not use alcohol, solvents, or other corrosive liquids.

Chapter 3: Highlighted Features

The following features require the latest UniGCS ground control station. Please obtain the app through official channels before use.

3.1 Dual Visible-Light Camera System with Dual 8K Capture

The MT11 integrates a dual visible-light system (wide-angle and zoom cameras), redefining professional imaging standards with dual 8K capture—the zoom and fixed lenses work in tandem, delivering 48MP detail across every frame, combining wide-area overview with fine-grained detail.

Wide-Angle Camera: 4.5mm focal length (equivalent 24mm), 84° diagonal FOV, supports 8K stills and 4K video recording, capturing expansive scenes in a single shot.

Zoom Camera: 15–50mm focal length (equivalent 81–270 mm), 48MP 8K stills and 4K @ 30fps video, enabling detailed capture from distant objects to mid-range close-ups, preserving clarity in every corner.

3.2 Next-Generation Focusing Algorithm

The MT11 supports both auto focus (AF) and manual focus (MF), allowing operators to select the optimal focus mode based on the scene complexity.

Auto Focus: The zoom camera supports spot focus and fast tracking focus. When

REEBOT

operating through the UniGCS app, operators can tap any area on the screen to set the focus point, achieving precise and rapid focusing. During zoom adjustments via the app or other control signals, the zoom camera automatically selects the optimal focus point, ensuring that the image is immediately sharp when zooming stops.

Manual Focus: For high-contrast, low-texture, or repetitive-pattern targets (e.g., metallic surfaces of power equipment, glass façades, or small distant objects), auto focus may misjudge and shift the focus point. Manual focus allows fine-tuned adjustment to lock the focus precisely on the target (e.g., bolts, cable connectors), ensuring critical details are captured clearly and avoiding AF hesitation or focus hunting.

In the app, two icons appear for manual focus: a “flower”-shaped icon and a “mountain”-shaped icon. In zoom camera mode, tapping the “flower” icon focuses on near-range objects, while tapping the “mountain” icon focuses on distant objects.



REEBOT

3.3 Up to 10T AI Computing Power

The MT11 equipped with 10T AI computing power, enabling AI functionalities such as object recognition and tracking without the need for an external AI module.

3.3.1 Intelligent AI Recognition and Tracking

The MT11 supports AI recognition and tracking. When AI recognition is enabled, detected objects of interest are marked with a white bounding box. Tapping the white box activates AI tracking, and tracked objects are highlighted with a blue bounding box. Default object models include humans, vehicles, and more. For vehicles, license plate recognition can be enabled, and the license plate number is displayed in real time, with the font color matching the plate color. Operators can also train custom models according to specific operational requirements.

3.3.2 Custom AI Models

The MT11 supports switching between different AI models to recognize a wider range of objects, including visible light, thermal imaging, insulators, and user-defined models.

User-defined models require the AI training platform UniAI Studio. After training, export the model logs. In the export folder, two output files will be generated. Copy both files to the root directory of a TF card, insert the card into the pod, and click Load AI Model. The system will automatically read the files, and selecting the custom recognition type allows you to verify whether the custom model is active.

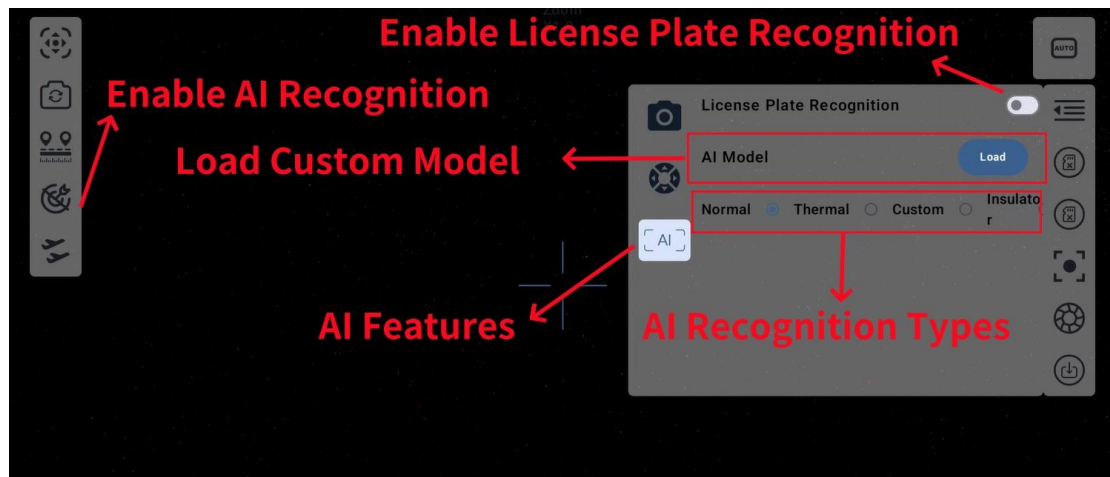

Note: When AI recognition is enabled, the gimbal automatically enters Lock Mode and gimbal operation modes cannot be changed. Normal operation resumes once AI recognition is disabled.

The model training workflow can be found in the AI Training Platform User Manual.

3.3.3 Region Selection Tracking

After enabling AI recognition, select the target of interest by drawing a bounding box. If the box covers more than 45% of an AI-recognized object, the system enters AI Tracking mode; otherwise, it performs arbitrary object tracking. The tracked object is highlighted with a blue bounding box.

3.3.4 AI Recognition Push & Multi-Country License Plate

Recognition

Before using these functions, ensure the following firmware and software versions are installed:

REEBOT

MT11 Gimbal Camera Firmware v1.0.2 or later

Camera Firmware: v1.0.11 or later

Gimbal Firmware: v1.0.5 or later

UniGCS APP v3.0.5 or later

AI Recognition Push

The MT11 supports recognition of multiple object categories and automatically counts detected targets by category.

Users can filter specific target types and enable AI Recognition Push. After enabling this function, the number of detected targets will be displayed in the upper-right corner of the video interface.

Multi-Country License Plate Recognition

The MT11 supports license plate recognition for multiple countries and regions. License plate recognition is available only when the tracked target is a vehicle and the license plate is clearly visible and recognizable. The color of the recognized license plate number matches the corresponding license plate color, while overseas license plate recognition results are displayed in blue.

The recognition language follows the system language setting. When recognizing license plates from other countries or regions, switch the system language to the corresponding language. With the ground station connected to the Internet, toggle the License Plate Recognition switch off and on again to load the corresponding recognition model.

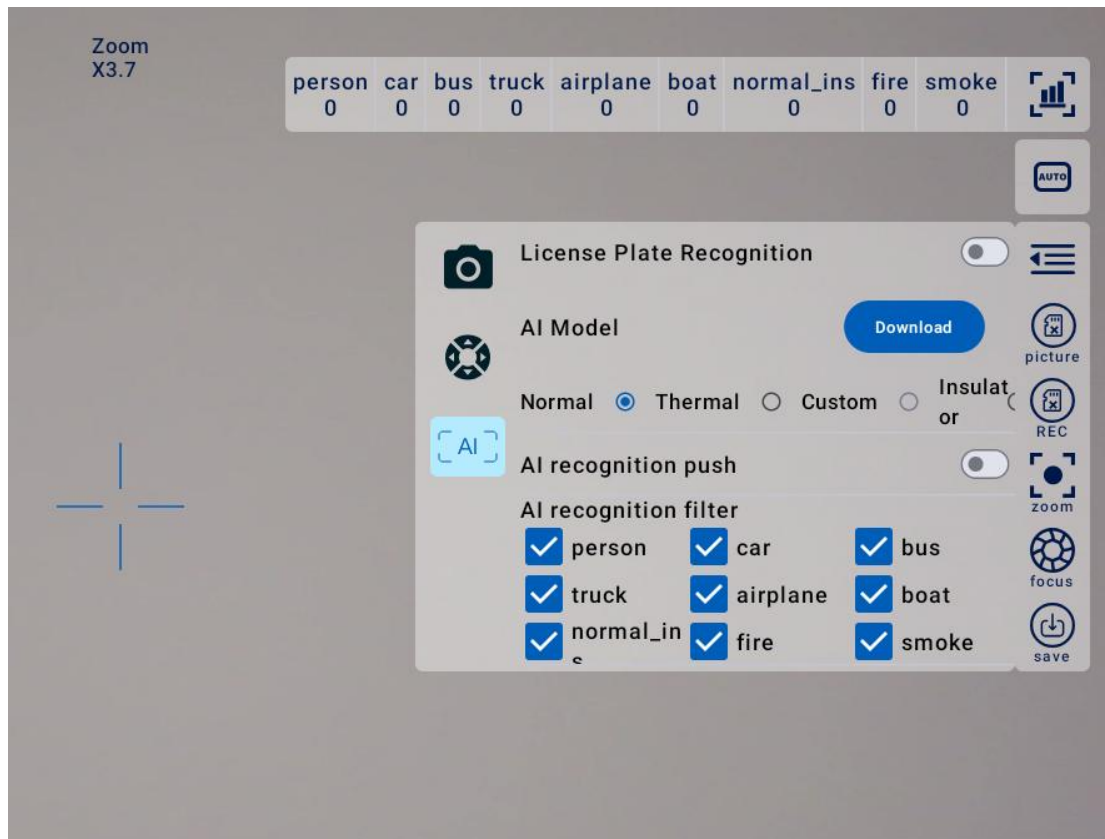

3.4 EIS Video Stabilization

The MT11 uses EIS (Electronic Image Stabilization) technology to improve the stability of visible-light video footage.

When enabled, EIS significantly improves video smoothness, making each frame appear as steady as if shot with a fixed-focus lens. Activating video stabilization during recording not only produces stable footage in real-time but also preserves it for later review.

Note: Video stabilization is available only when using the visible-light camera. This function is not supported when Night Vision Mode is enabled. When video stabilization is enabled, AI Tracking and Double-Tap Targeting are unavailable.

Under severe operating conditions with excessive vibration, the effectiveness of video stabilization may be limited. Additional vibration isolation or damping measures are recommended to reduce environmental impacts on system stability.

3.5 ISP Parameter Adjustment

The MT11 supports adjustment of multiple camera parameters, including Brightness, Saturation, Contrast, Exposure Compensation (EV), Shutter Speed (SS), White Balance (WB), ISO, etc. All parameters can be adjusted simultaneously.

The MT11 also supports three metering modes: Average, Center-weighted, and Spot Metering. Proper parameter adjustment allows the pod to capture distinct lighting effects under the same environmental conditions.

In the APP main interface, tapping the AUTO icon expands the parameter sliders. The sliders is draggable, and at the end of the panel, icons for Restoring Default Parameters and Collapsing the Panel are available. If the adjusted parameters do not produce the desired effect, one tap restores the default settings.

REEBOT

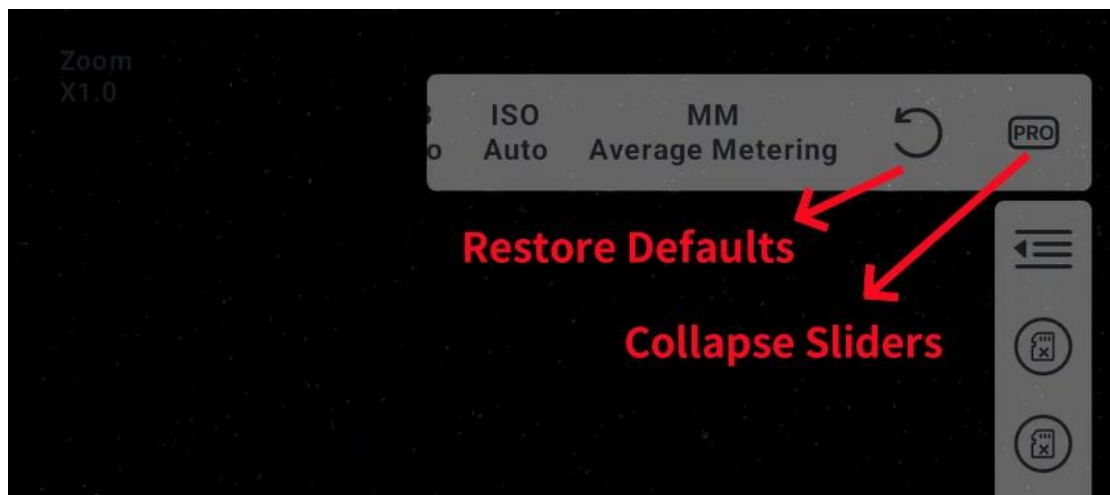

Comparison of Images Before and After Parameter Adjustment:

√ **Default Parameters (Unadjusted):**

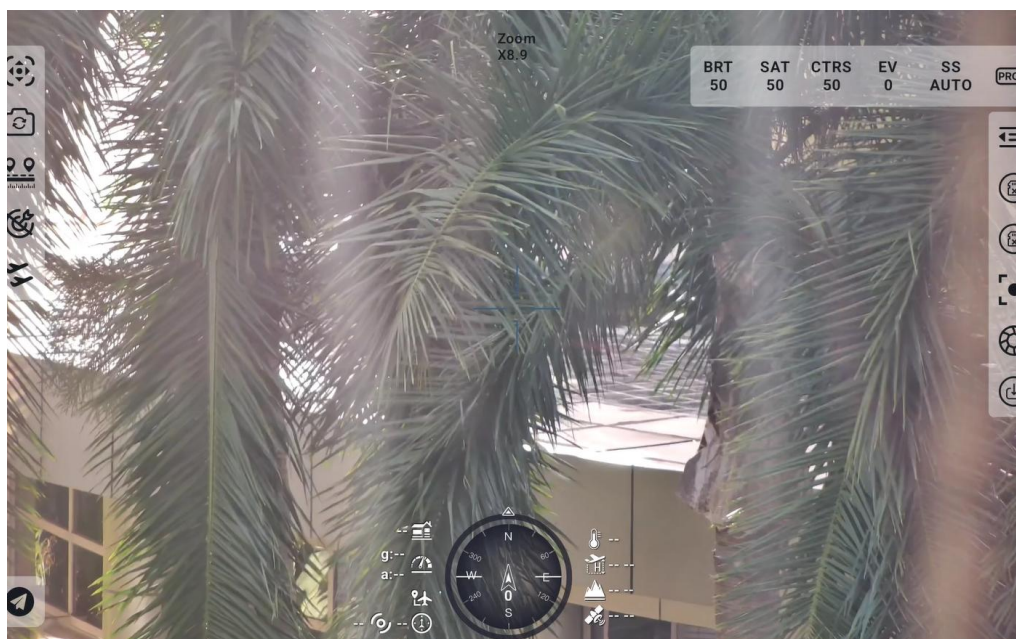

REEBOT

√ After Adjusting Selected Parameters:

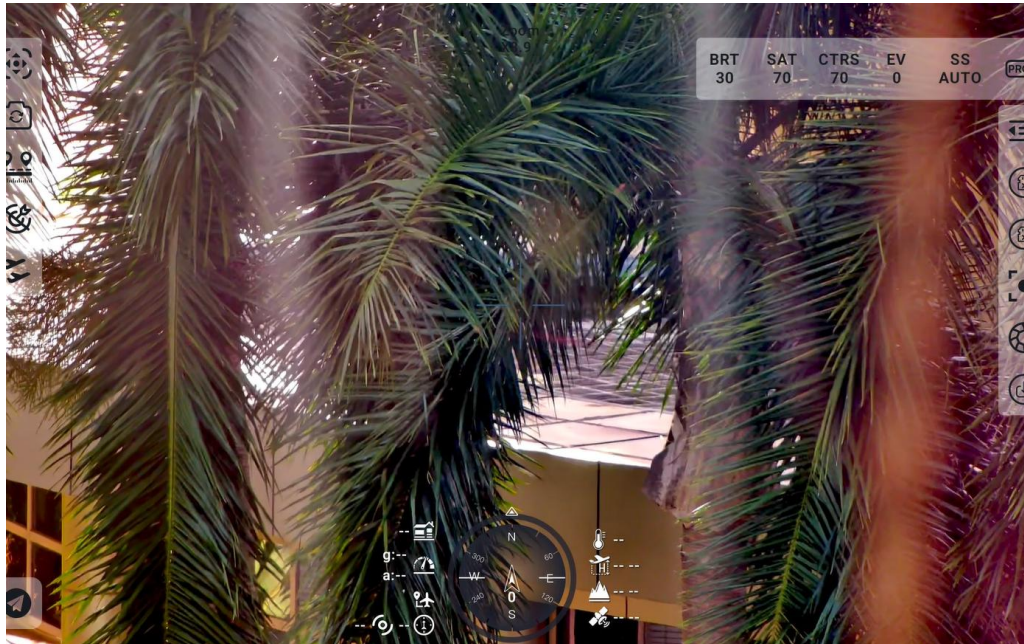

Adjustable Parameter Ranges:

Brightness: 0–100 (Default: 50)

Saturation: 0–100 (Default: 50)

Contrast: 0–100 (Default: 50)

White Balance (WB): Auto, Daylight, Cloudy, Fluorescent, Incandescent (Default: Auto)

Exposure Compensation (EV): -10 to 10 (Default: 0)

ISO: Auto, 100, 200, 400, 800, 1600, 3200 (Default: Auto)

Metering Mode: Average, Center-weighted, Spot (Default: Average)

Shutter Speed (SS): 1/30s, 1/50s, 1/100s, 1/250s, 1/500s, 1/750s, 1/1000s, 1/2000s (Default: Auto)

 **Note:** When the parameter panel is expanded, any adjustments will take effect immediately. Photos or videos captured will reflect the adjusted parameters. To capture images or videos with the original settings, close the parameter panel or restore the default parameters before capturing.

REEBOT

3.6 Modify IP Address

The MT11 supports modifying the IP address and other parameters. Always note the updated IP address. After changing the IP, ensure the pod and the link device are on the same subnet; otherwise, the pod will not output video.

3.6.1 Online IP Address Modification

The MT11 gimbal supports online configuration of the IP address, gateway, and subnet mask. Operators may adjust these settings according to operational requirements.

Within the IP configuration interface, the IP address, gateway, and subnet mask can be modified. After making changes, click Save to confirm. Parameters that are not modified will remain at their default values and will not be displayed.

The gimbal operates normally without modifying the IP address. If the IP address is changed, ensure that the configuration is recorded and that the gimbal IP and the connected network device IP remain within the same subnet.

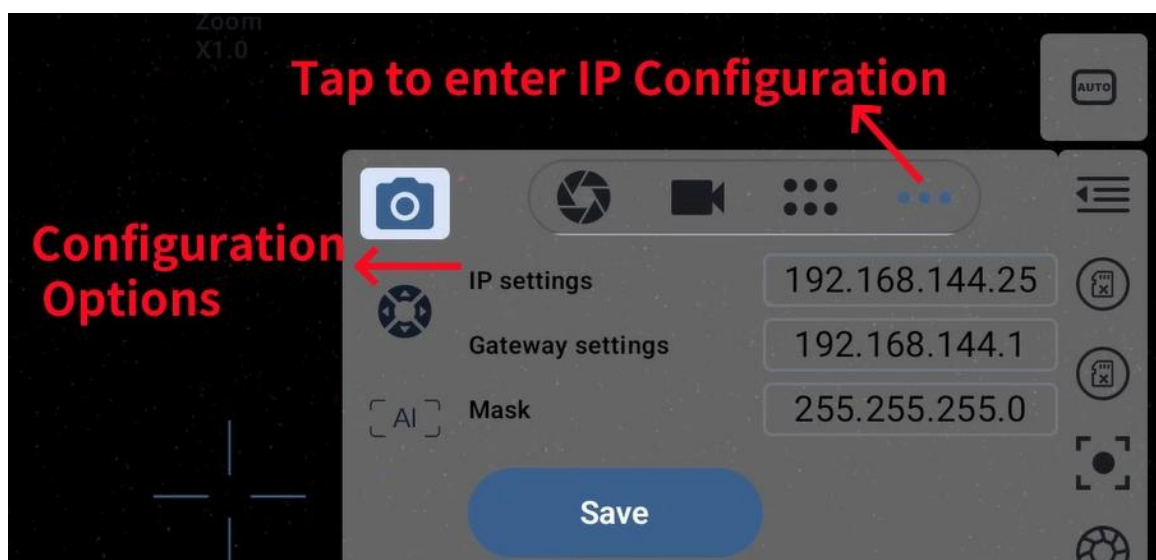

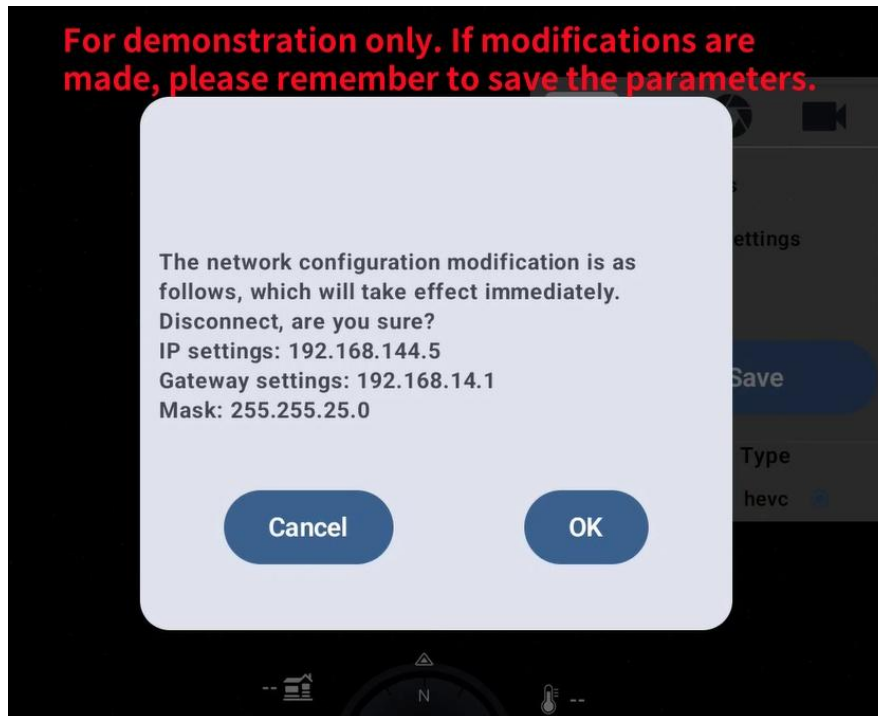

Default Primary IP Address: 192.168.144.25

Default Primary RTSP Address: rtsp://192.168.144.25:8554/video1

Secondary stream RTSP address: rtsp://192.168.144.25:8554/video2

Secondary IP Address: 192.168.144.80

Secondary RTSP Address: rtsp://192.168.144.80:8554/video1

After changing the device IP, a reboot is required for the secondary IP RTSP stream to function.



Note: When transmitting video via the data link, ensure that the link IP and the gimbal IP are within the same subnet; otherwise, video transmission will fail.

3.6.2 IP Address Scanning (Within the Same Subnet)

When the user-configured IP address and the data link IP address are within the same subnet, quick video transmission can be achieved by scanning IP addresses.

REEBOT

Tap the three-dot menu at the top-right corner of the main interface to enter the Camera Address Selection page, then tap the Scan button to view the IP addresses of all MT11 gimbals within the same subnet as the data link.

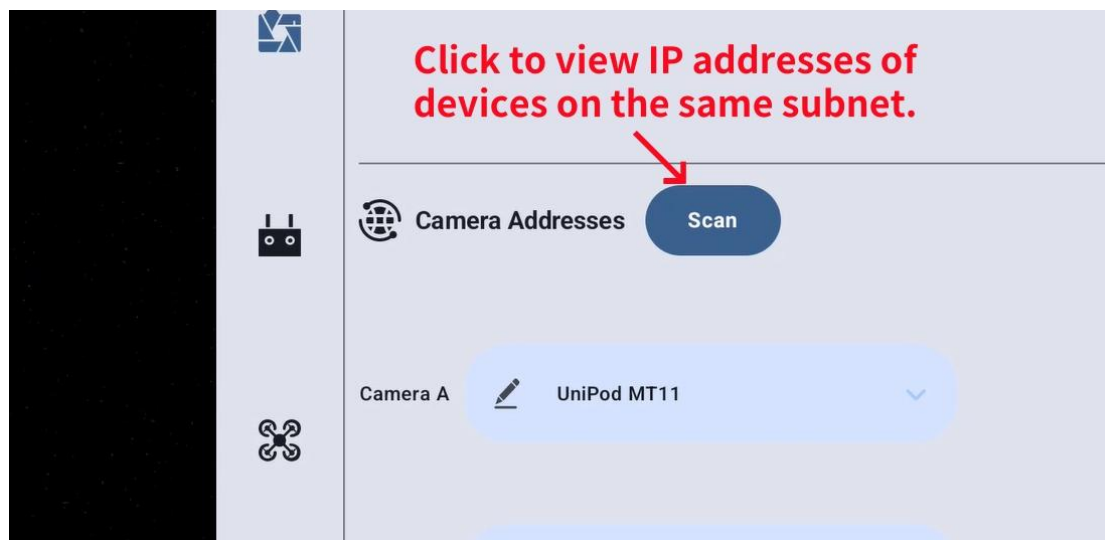

Tap the corresponding IP address to use the modified IP for video transmission, or tap the Reset button to restore the gimbal to its default IP address.

3.6.3 If the Modified IP Is Forgotten

√ Gimbal IP and Data Link IP Are in the Same Subnet

Use the scan function in the link APP and tap the detected IP to resume video transmission.

After locating the camera IP, click the Reset button to restore the camera to its default IP. Clicking Reset All will restore all detected camera IPs to their default addresses.

√ Gimbal IP and Data Link IP Are in Different Subnets

Restart the MT11 and obtain the video stream using one of the following methods:

After reboot, use the Scan function to detect the camera IP. Set the data link IP to a non-conflicting address in the same subnet as the camera, then enter the camera IP to

REEBOT

display video.

Alternatively, after reboot, scan for the camera IP and click the Reset button next to the address. Wait briefly for the gimbal to restore its default IP.

Or, after reboot, directly enter the RTSP stream address:

`rtsp://192.168.144.80:8554/video1` to view the video feed.

Use the IP scan function; after the gimbal IP is detected, tap Reset or Reset All. The camera will then revert to its default IP address.

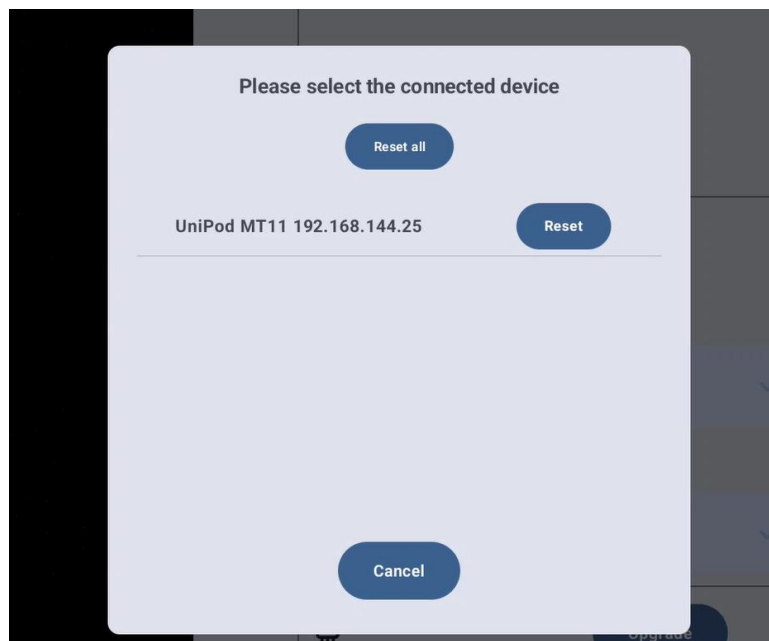

Note: If the pod IP and the link device IP are not on the same subnet, the video will not display even if the app detects the pod IP. Always ensure the pod IP and link IP are on the same subnet.

3.7 Electronic Dehaze

The MT11 features an electronic defog function that restores image clarity in foggy or high-humidity conditions. In conventional foggy environments, scattering can cause

REEBOT

distant targets to appear washed out and lose detail. The MT11 enhances contrast for light fog, delineating edges of vegetation and structures, ensuring critical details remain visible and minimizing the risk of target misidentification.

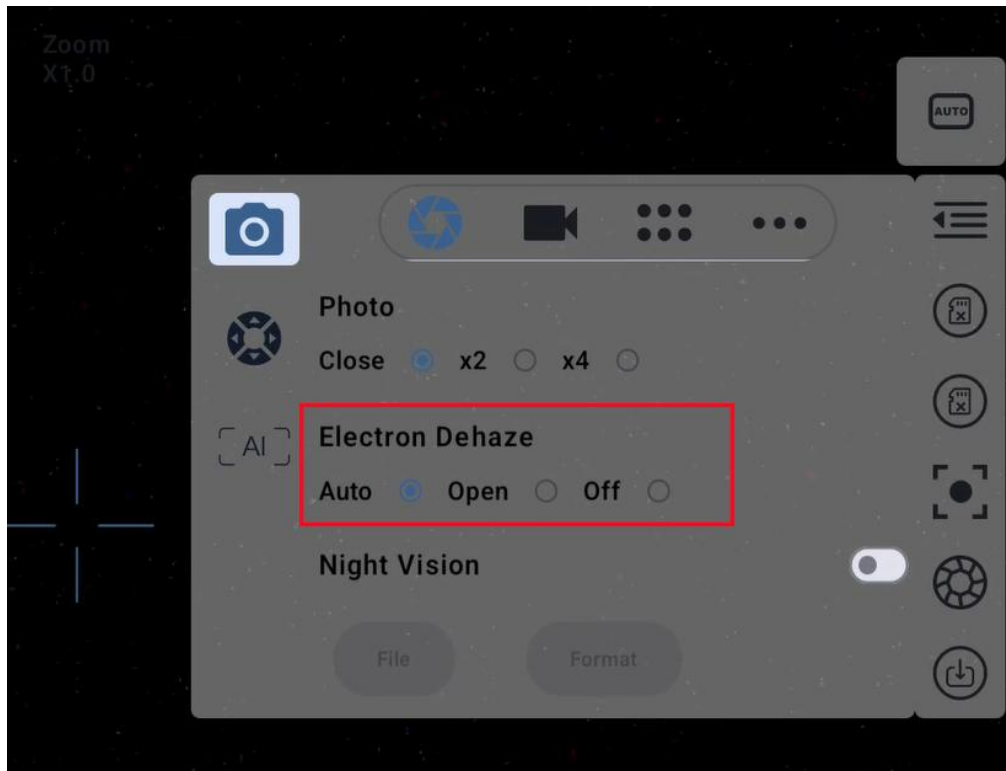

3.8 Night Vision Mode

The MT11 supports Night Vision Mode. Activating this mode enhances the MT11's low-light imaging capabilities and effectively reduces image noise.

 **Note: When Night Vision Mode is enabled, AI Tracking, AI Super-Resolution, and Electronic Image Stabilization (EIS) functions are disabled.**

3.9 Double-Tap Targeting

The MT11 visible-light camera supports the Double-Tap Targeting function, allowing

REEBOT

users to quickly align the gimbal with a target by double-tapping it on the screen. Before using this function, ensure the following firmware and software versions are installed:

MT11 Firmware v1.0.2 or later (Camera Firmware v1.0.11 or later, Gimbal Firmware v1.0.5 or later)

UniGCS APP v3.0.5 or later

In the visible-light camera view, double-tap a target to quickly align the gimbal toward it. The target cannot be aligned when it is near the gimbal's movement limits. The farther the tapped position is from the center of the image, the lower the targeting accuracy may be.

A slight drift after target alignment is normal when the gimbal is operating in Follow Mode. In Lock Mode, the aligned target position will remain stable without drift.

Chapter 4: Gimbal Control

4.1 Controlling the Gimbal via UniGCS APP on the Link Device

The MT11 supports multiple methods for controlling gimbal rotation. Before operation, ensure that the gimbal and camera firmware, as well as the software, are updated to the latest versions.

4.1.1 Gimbal Rotation Control and One-Touch Rotation

√ Gimbal Rotation Control

Run the latest version of the UniGCS ground station software. Tap the three dots in the upper-left corner to access the camera address selection interface, select MT11 for video output, and return to the main interface. Long-press on an empty area for one second to display a circular control icon. Dragging this icon allows manual control of the gimbal rotation—the farther the icon is from the center, the faster the gimbal rotates.

√ One-Touch Rotation:

One-Touch Return to Center: Both pitch and yaw return to the center position.

One-Touch Yaw Center, Pitch Down: Yaw returns to center, pitch moves down 90° (inverted view upward 90°).

One-Touch Yaw Center: Yaw returns to center while pitch remains unchanged.

One-Touch Pitch Down: Pitch moves down 90° (inverted view upward 90°) while

REEBOT

yaw remains unchanged.



 Note: The gimbal rotation speed decreases as the zoom level increases.

4.1.2 Photo Capture Control

To capture photos or record videos, a TF card must be prepared. Supported TF card formats are FAT32 or exFAT. Before shooting, insert the TF card into the MT11 gimbal's TF card slot. When the TF card is recognized, the photo/video icon in the APP will display a solid black circle at its center.

Selecting Capture Views: The MT11 supports simultaneous recording from multiple camera views, including zoom, thermal, and dual-view modes. Operators can select any combination or all options. Pressing the photo button will capture the selected views. When all views are selected, pressing the photo button generates three separate image files, each corresponding to a different camera view. File name suffixes

REEBOT

indicate the view: Z for zoom, I for thermal, and C for dual-view.

8K Photo Capture: To take 8K photos, enable the 8K photo resolution switch and select the zoom view as the capture source; otherwise, visible-light photos will not be generated. During 8K photo capture, the gimbal should be kept as still as possible to avoid motion blur. A successful capture will trigger a confirmation notification.

8K Capture Logic:

For wide-angle view ($1\times < \text{zoom} \leq 3.3\times$), the 8K photo captures the $1\times$ view.

For zoom levels between $3.3\times$ and $11\times$, the 8K photo captures the current zoom view.

For zoom levels above $11\times$, the 8K photo captures the $11\times$ view. Example: If the zoom is set to $165\times$, the actual 8K photo captures the scene at $11\times$ zoom.

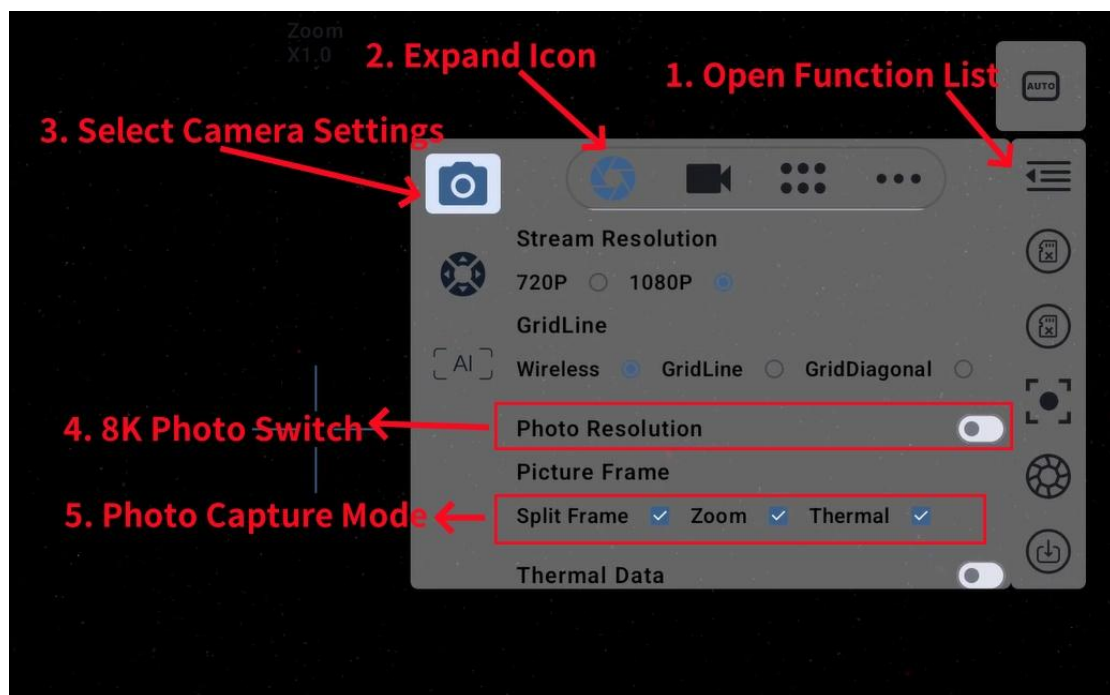

Note: Photos or videos cannot be captured if no capture view is selected. 8K photo capture is only supported by the visible-light camera. Supported photo resolutions are limited to 4K and 8K.

REEBOT

4.1.3 Video Recording Control

The MT11 supports simultaneous recording from multiple camera streams. Before starting recording, insert a TF card into the gimbal and select the desired recording streams, then tap the record button to begin recording.

Recording Streams: Current View: Records the main and sub-streams. Possible combinations include: main stream visible light with sub-stream thermal, main stream dual-view with sub-stream thermal, or main stream thermal with sub-stream visible light. When recording the current view, both main and sub-stream resolutions are 1080P.

Zoom: Records the visible-light zoom stream.

Thermal: Records the thermal imaging stream.

All Streams: Selecting all streams will produce four video files upon completion. The file names differ to indicate different recording streams, with suffixes as follows: A for main stream, B for sub-stream, Z for visible-light, and I for thermal imaging.

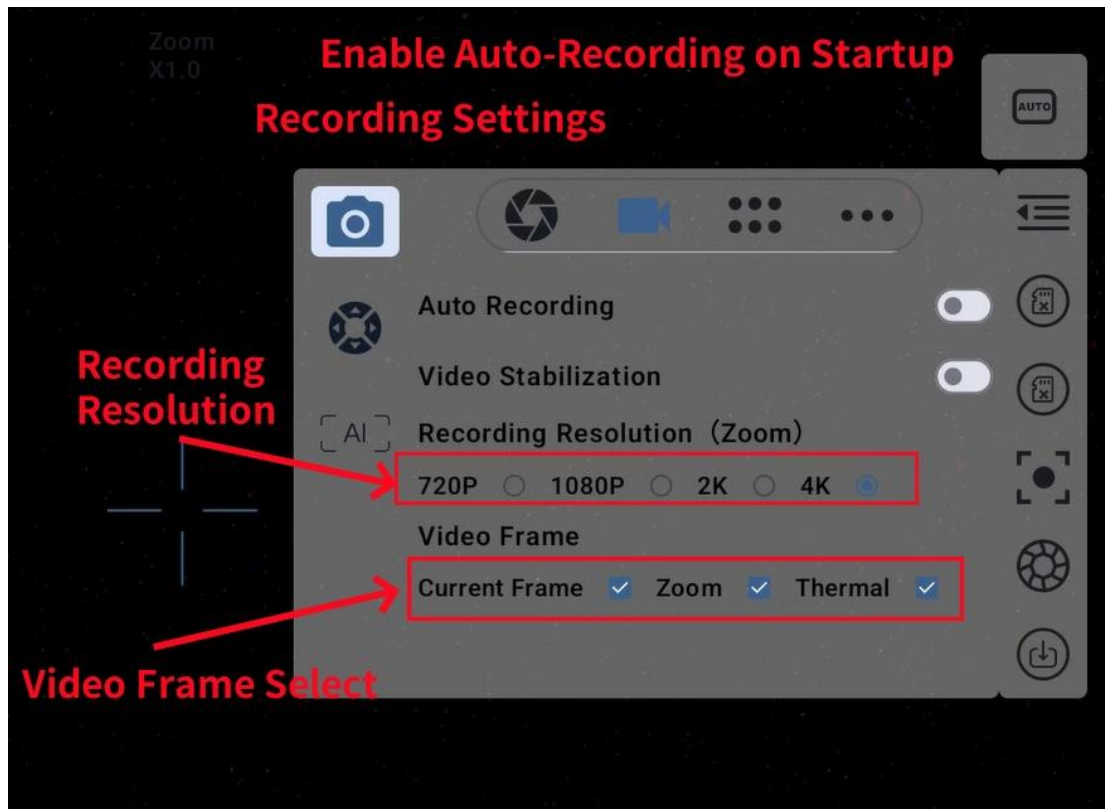

 Note: Changes to the recording streams take effect only before starting the recording. Modifying the recording resolution applies solely to the zoom (visible-light) stream.

4.1.4 Photo and Video File Name Conventions

The file names of photos and videos captured by the MT11 indicate the corresponding camera stream.

Photos:

C – Dual-view (split-screen) image

I – Thermal imaging

Z – Visible-light image

REEBOT

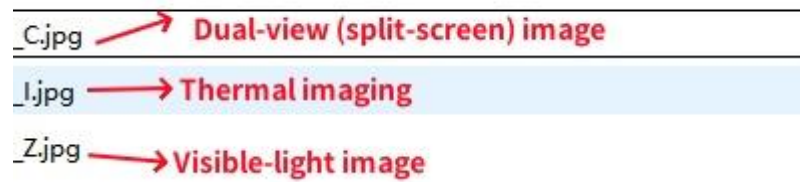

Videos:

I – Thermal imaging

B – Sub-stream

A – Main stream

Z – Visible-light image

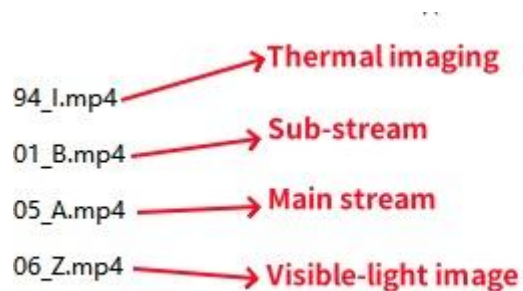

 Note: Capturing photos or recording videos is not possible if no camera view is selected. 8K photography is supported only by the visible-light lens.

4.1.5 Zoom Control

The MT11 supports two zoom methods. The first is standard zoom(relative zoom), controlled via the “+” and “-” buttons. The second is absolute zoom, adjusted by sliding the zoom bar. Both methods meet different zooming requirements.

Standard Zoom: Use the “+” button to zoom in and the “-” button to zoom out.

Absolute Zoom: Slide the zoom bar to adjust the zoom level. Sliding upward zooms

REEBOT

in, and sliding downward zooms out.

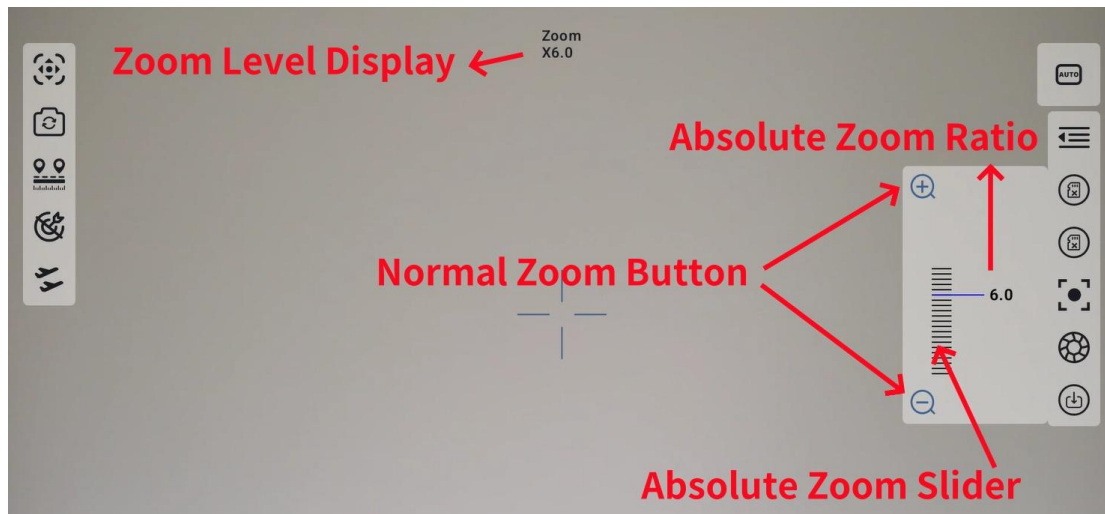

4.2 UniGCS APP Channel Configuration for Controlling the Gimbal via S.BUS Signal Forwarding

4.2.1 Cable Connection

The MT11 supports direct control of the gimbal using the S.BUS signal from the link device. The following demonstrates how the MT11 forwards the S.BUS signal from the link device to the flight controller via an S.BUS forwarding cable, while simultaneously controlling the gimbal.

Required items include: the link device (remote controller, sky unit, and S.BUS control cable), the MT11 S.Bus Y-Splitter Cable (included in the package), and the flight controller.

Wiring Diagram

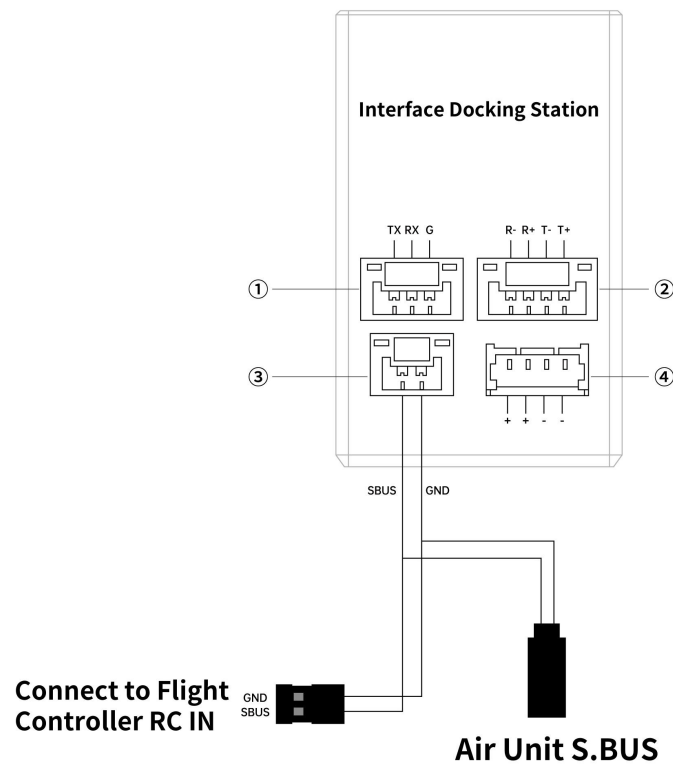

After completing the cable connection, the designated channels and corresponding actions need to be configured in the APP. The MT11 supports S.BUS signal control for camera functions including photo capture, video recording, auto focus, manual focus, and zoom. It also supports gimbal control functions such as horizontal rotation, pitch rotation, one-key center return, one-key downward, and switching gimbal operating modes.

4.2.2 Camera Control

After completing the cable connection, the designated channels and corresponding actions must be configured in the UniGCS APP. The MT11 supports S.BUS signal control for camera functions including photo capture, video recording, auto focus, manual focus, image stitching and zoom. Up to 16 channels can be configured.

REEBOT

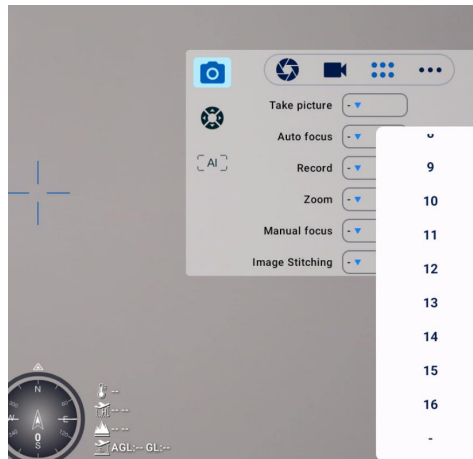

Once the channels are configured, the camera can be controlled to execute the assigned commands using the configured channels.

4.2.3 Gimbal Control

After completing the cable connection, designated channels and corresponding actions must be configured in the UniGCS APP. The MT11 supports S.BUS signal control for gimbal functions, including horizontal rotation, pitch rotation, one-key return to center, one-key downward position, and switching gimbal operating modes.

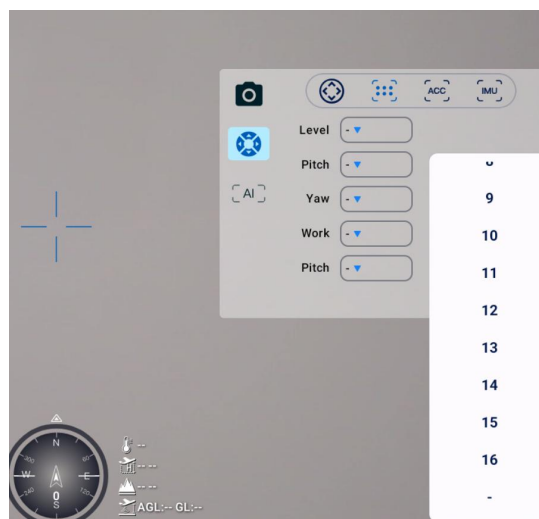

Once the channels are configured, the gimbal can be controlled to perform the assigned actions using the configured channels.

4.3 Integrating Flight Controller Data

The MT11 UART interface can be directly connected to the ArduPilot flight controller UART port to communicate and integrate flight controller attitude data. After integration, the system can provide real-time feedback on gimbal image stability during flight.

Before use, the following tools, firmware, and software should be prepared:

1× MT11 with firmware version 0.0.8 or above (camera firmware 1.0.5, gimbal firmware 0.1.6 or above)

1 × ArduPilot flight controller (firmware version 4.4.4 or above)

ArduPilot-PX4 flight controller UART to gimbal UART connection cable (standard accessory)

UniGCS Android or UniGCS PC

Procedure for Use:

1. Power on both the MT11 gimbal and the ArduPilot flight controller.
2. Connect the gimbal UART port to the ArduPilot flight controller UART port, ensuring both devices are in communication mode.
3. Launch the ground control software and configure the following parameters (example for using the flight controller TELEM 2 interface):

Set SERIAL2_BAUD to 115 (corresponding to a baud rate of 115200).

Set SERIAL2_PROTOCOL to 2 (corresponding to MAVLink2).

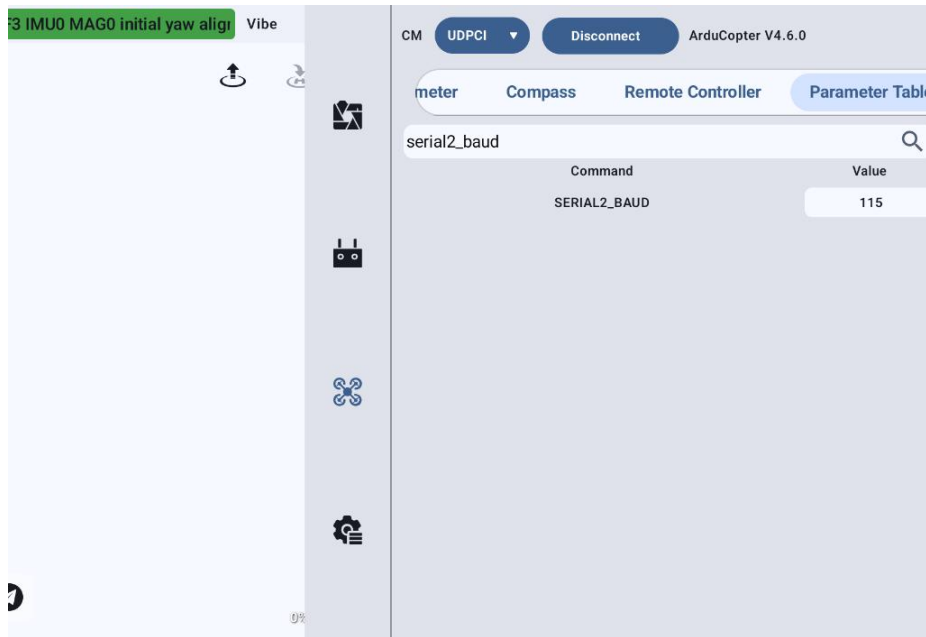

After configuring, write the parameters to the flight controller and restart it for the settings to take effect.

 **Note: Integrating flight controller attitude data can enhance gimbal performance during high-agility maneuvers of the drone.**

4.4 Controlling the Gimbal Camera via UART with ArduPilot

The MT11 UART port can be directly connected to the ArduPilot flight controller (FC) UART port to exchange flight data. By integrating FC attitude data, the pod can provide real-time feedback on image stability during flight.

The MT11 supports gimbal and camera control via MAVLink and proprietary protocols, and can embed location and attitude information into photos.

Required tools, firmware, and software before use:

REEBOT

1× MT11 pod with firmware version 0.0.8 or above (camera firmware 1.0.5, gimbal firmware 0.1.6 or above)

1× ArduPilot flight controller (firmware 4.4.4 or above)

Standard UART cable connecting ArduPilot-PX4 FC to MT11 UART port

UniGCS Android or UniGCS PC



Note: When using the proprietary protocol, the FC firmware must be version 4.6.0 or above. Otherwise, the pod cannot acquire location data, and laser rangefinder results will not display target coordinates.

4.4.1 Controlling Gimbal Attitude and Camera Functions via

MAVLink Protocol

Parameter Configuration:

1. Power on both the MT11 pod and the ArduPilot flight controller.
2. Connect the MT11 UART port to the ArduPilot FC UART port using the supplied cable to establish communication.
3. Launch the ground station software, locate all parameters, and configure them as follows:

Example using the FC TELEM1 interface:

SERIAL1_BAUD = 115 → Baud rate 115200

SERIAL1_PROTOCOL = 2 → MAVLink2

CAM1_TYPE = 6 → MAVLinkCamV2

MNT1_TYPE = 4 → SToRM32 MAVLink

After writing the above parameters, modify the following gimbal limits:

MNT1_RC_RATE = 90

MNT1_PITCH_MAX = 20

REEBOT

MNT1_PITCH_MIN = -90

MNT1_YAW_MAX = 180

MNT1_YAW_MIN = -180

Once all settings are configured, write the parameters to the FC and power cycle to apply the changes.

Basic Functions

After completing the above parameter configuration, specific RC channels can be assigned in the UniGCS APP to execute designated actions. Channels 1–16 are supported, but avoid using channels required by the flight controller to prevent conflicts. Supported actions include:

- Camera: photo, video recording, zoom, autofocus, image stitching and manual focus
- Gimbal: yaw rotation, pitch rotation, one-key return-to-center, one-key down, gimbal mode switching

Direct S.BUS connection to the gimbal allows the above controls. When controlling the gimbal via MAVLink protocol without S.BUS connected, the same RC channel actions can still control the MT11 gimbal and camera.

Waypoint Photogrammetry Function

When the flight controller is configured to control the gimbal and camera via MAVLink, custom waypoint missions can be created in UniGCS APP, with waypoint actions set to the photo command.

For mapping missions, create a survey flight path in UniGCS APP, select the MT11

REEBOT

camera, and configure the relevant parameters to enable photogrammetry functions.

4.4.2 Controlling Gimbal and Camera Functions via proprietary

Protocol

When using the proprietary protocol to control the gimbal and camera, the ArduPilot flight controller firmware must be version 4.6.0 or above. Otherwise, the gimbal camera cannot acquire position information, and the laser rangefinder cannot display target latitude and longitude coordinates.

Parameter Configuration:

1. Power on both the MT11 and ArduPilot flight controller.
2. Connect the gimbal UART port to the ArduPilot flight controller UART port using the supplied cable to establish communication.
3. Open the ground station software, access the full parameter list, and set the following parameters:

For example, using the flight controller TELEM1 interface:

`SERIAL1_BAUD = 115` → Baud rate 115200

`SERIAL1_PROTOCOL = 8` → Gimbal

`CAM1_TYPE = 4` → Mount (Siyi/Topotek/Viewpro/Xacti)

`MNT1_TYPE = 8` → SIYI

Write the parameters, then modify:

`MNT1_RC_RATE = 90`

`MNT1_PITCH_MAX = 20`

`MNT1_PITCH_MIN = -90`

`MNT1_YAW_MAX = 180`

REEBOT

MNT1_YAW_MIN = -180

Save parameters and power cycle the flight controller for changes to take effect.

Configure RC channel 6 options as needed:

RC6_OPTION = 213 → Mount1 Pitch (control gimbal pitch via CH6)

RC6_OPTION = 214 → Mount1 Yaw (control gimbal yaw via CH6)

RC6_OPTION = 9 → Camera Trigger (control photo capture via CH6)

RC6_OPTION = 166 → Camera Record Video (start/stop video via CH6)

RC6_OPTION = 167 → Camera Zoom (control zoom via CH6)

RC6_OPTION = 168 → Camera Manual Focus (manual focus via CH6)

RC6_OPTION = 169 → Camera Auto Focus (auto focus via CH6)

RC6_OPTION = 163 → Mount Lock (toggle gimbal Lock/Follow mode via



Note: The above RC6_OPTION functions are for demonstration only. Actual channel assignments should be based on specific setup. Each channel should be assigned a single function to avoid conflicts.

RC5_OPTION flight controller Channel 5 configuration parameters do not take effect. Avoid using this option.

When modifying flight controller parameters via the proprietary protocol to control the gimbal and using direct S.BUS control configured in UniGCS, both control methods take effect simultaneously. Ensure no channel conflicts are configured.

4.5 AI Follow Mode

The MT11 features 10 TOPS onboard AI computing power. When used with UniGCS and an open-source flight controller, it supports AI Follow Mode, enabling the drone to automatically follow a selected target.

REEBOT

Before using this function, ensure the following hardware, firmware, and software are available:

1 × MT11 firmware version v1.0.2 or later (Camera Firmware v1.0.11 or later, Gimbal Firmware v1.0.5 or later)

1 × ArduPilot flight controller (Firmware v4.4.4 or later)

UART connection cable between the ArduPilot/PX4 flight controller and the MT11 gimbal (included)

UniGCS APP (v3.0.5 or later)

Setup Procedure

1. Ensure that the MT11 firmware and UniGCS software are updated to the latest version or a version that supports AI Follow Mode.
2. Ensure that the MT11 is properly connected to the flight controller, the air unit communication link is functioning normally, and video transmission and gimbal control are available in UniGCS.
3. Configure the flight controller parameters to enable telemetry data integration.

Using the TELEM2 port as an example:

Set SERIAL2_BAUD to 115 (115200 baud).

Set SERIAL2_PROTOCOL to 2 (MAVLink2).

Adjust WPNAV_SPEED according to the required follow speed.

After configuration, write the parameters and reboot the flight controller for the changes to take effect.

4. Verify that flight controller data is correctly integrated into the gimbal system.

When telemetry integration is successful, the MT11 status LED flashes green

REEBOT

twice repeatedly, and the flight controller integration icon is displayed in the software.

When AI Recognition is enabled, the AI Tracking icon appears white.

When tracking is active, the icon turns green.

When AI Follow Mode is activated, the follow icon turns blue.

5. Select a target and tap the Follow icon. The drone will enter AI Follow Mode, and the flight controller will automatically switch to Guided Mode and follow the target. If the target is lost, tracking fails, or AI Follow Mode is canceled, the drone will hover automatically.
6. AI Follow Mode is supported only when the MT11 is installed in the standard upright orientation. If the tracked target is directly beneath the gimbal, above the gimbal, or approximately at the same level as the gimbal's line of sight, AI Follow Mode cannot be activated. A corresponding prompt will be displayed in the software. If AI Follow Mode still cannot be activated when the target is approximately 45° below the gimbal, place the drone on a level surface and perform horizon calibration.
7. If tracking is canceled during AI Follow Mode, the drone will hover and wait for a new target to be selected. Once a new target is selected, AI Follow Mode will resume automatically. Disabling AI Recognition will automatically exit AI Follow Mode. Tapping the Follow icon to cancel AI Follow Mode will also exit the mode. However, neither of these actions returns manual control of the drone to the operator. To regain control, switch the flight controller to another flight mode.

REEBOT



Danger: When AI Follow Mode is active, the operator cannot manually control the drone, and Guided Mode commands from the ground station are unavailable. To regain manual control, switch the flight controller to another flight mode.

When AI Follow Mode is active, the drone maintains its current flight altitude. Ensure the planned follow path is clear of obstacles and maintain continuous awareness of flight safety. If obstacles are encountered, immediately take over manual control and replan the flight path.

The tracked target should remain on a relatively level plane of movement. If the tracking target is lost, the drone will automatically hover.

Chapter 5: Video Output

The MT11 supports video stream output through the Ethernet interface in multiple formats.

5.1 Video Output via UniGCS APP

When used with the UniGCS APP, the MT11 supports Ethernet video output in both single-camera single-stream and single-camera dual-stream modes.

√ Single-Camera Video Output

Single-camera video output refers to MT11 transmitting a single video stream through the UniGCS APP.

Operators can select MT11 output from either Camera Address A or Camera Address B.

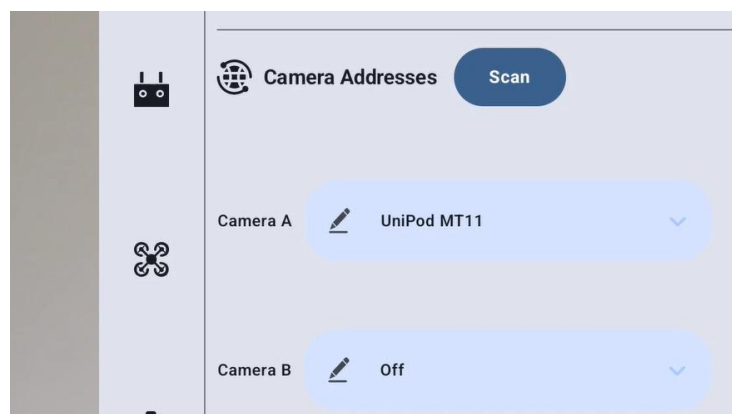

√ Single-Camera Dual-Stream Output

The MT11 supports dual-stream output from a single camera by assigning its primary stream and secondary stream to two separate camera address slots. In this

REEBOT

configuration, UniPod MT11 SubStream corresponds to the secondary stream of the MT11.

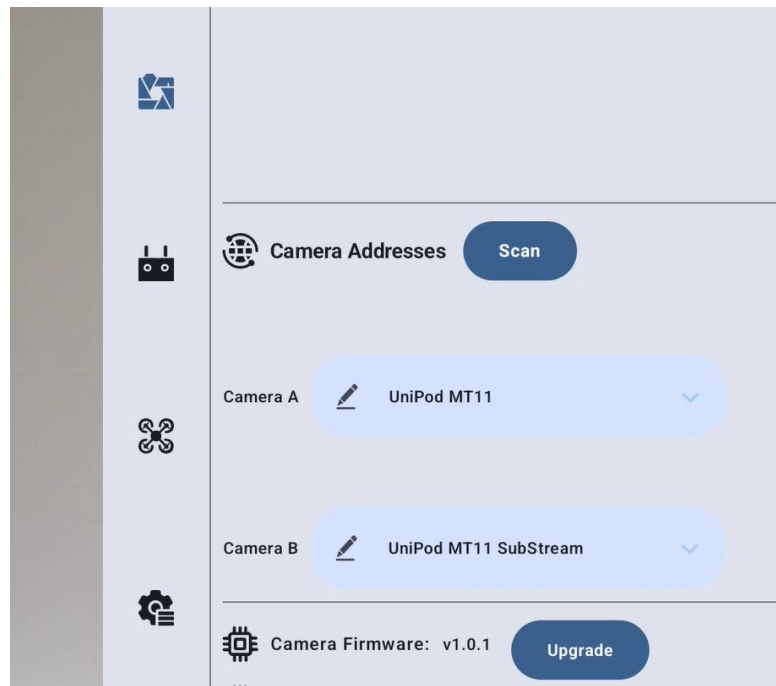

Single-Camera Dual-Stream Output



REEBOT

5.2 Video Output via Direct Ethernet Connection to Windows Device (e.g., PotPlayer)

The MT11 Mini Quad-Sensor AI Gimbal Payload supports direct Ethernet connection to a Windows device, enabling video output to third-party applications via RTSP stream.

Use the standard MT11 Ethernet-to-RJ45 cable to connect the payload to the computer. If direct connection is not possible, a USB-to-Ethernet hub can be used to establish the link through a computer USB port.

Configure the computer's Ethernet settings to match the subnet of the MT11, ensuring that the IP address does not conflict. For example: IP address 192.168.144.30.

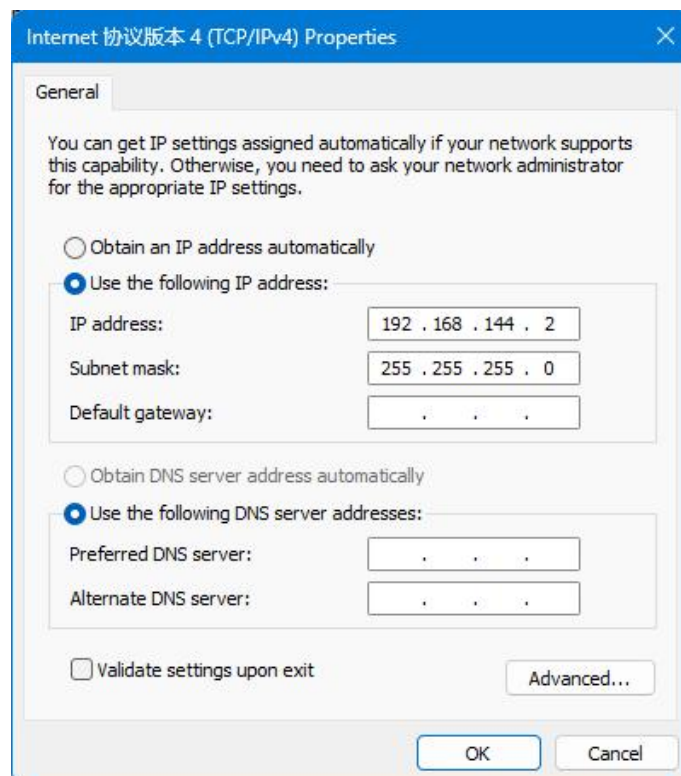

Open the PotPlayer software, select “Open”, then click “Open URL”.

REEBOT

Enter the RTSP address: `rtsp://192.168.144.25:8554/video1`.

Click OK to start video streaming.

5.3 EasyPlayer Four-Stream Playback

Connect the MT11 to the computer via Ethernet cable and launch EasyPlayer on the computer.

In the four-stream input fields, enter `rtsp://192.168.144.25:8554/video1`, then click Start to begin video streaming.

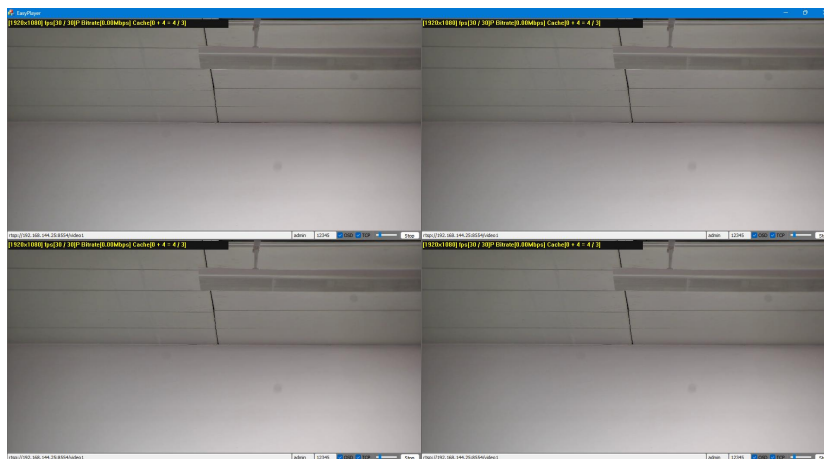

5.4 Common Device Stream Addresses

Primary IP Address: 192.168.144.25

Primary Stream URL: `rtsp://192.168.144.25:8554/video1`

Secondary Stream URL: `rtsp://192.168.144.25:8554/video2`

REEBOT

5.5 Troubleshooting Video Output Issues

1. If the optical pod video stream fails to display, perform the following initial checks:
2. Verify that the ground unit and airborne unit are properly linked, and ensure the camera is securely connected to the airborne unit.
3. Confirm that the correct camera IP address and RTSP stream address are entered in the application.
4. If using the UniGCS APP, check the connection status, application version, and video stream address settings.
5. If using a handheld ground control station, verify that the Android Ethernet switch is enabled.
6. Check whether the gimbal camera IP address was unintentionally modified.

If the video stream still does not display, perform a more in-depth check according to your video transmission method and display device.

On a Mobile Device

Use the Ping Tools application to ping the gimbal camera's default IP address 192.168.144.25 to verify network connectivity. Check that the RTSP address entered in the video player is correct if the network responds.

Network Communication Normal

The screenshot shows a network utility interface with a teal header. The title bar contains a menu icon, the text 'Ping', and a three-dot menu icon. Below the header is a search bar containing the IP address '192.168.144.25' and a 'PING' button with a network icon. The main content area displays the following information:

- Ping 192.168.144.25**
ICMP
- From 192.168.144.25**
Sequence 1, size 64 bytes, ttl 64 19 ms
- From 192.168.144.25**
Sequence 2, size 64 bytes, ttl 64 20 ms
- From 192.168.144.25**
Sequence 3, size 64 bytes, ttl 64 18 ms
- Ping statistics:**
3 transmitted, 3 received, 0% packet loss, time 3144 ms
- Time statistics:**
Min 18 \ avg 19 \ max 20 \ mdev 1 ms

Network Communication Failure

The screenshot shows the same network utility interface as above, but with a failure state. The search bar and 'PING' button are identical. The main content area displays the following information:

- Ping 192.168.144.25**
ICMP
- Connection Timeout**
Sequence 1, no answer yet ⓘ
- Connection Timeout**
Sequence 2, no answer yet ⓘ
- Connection Timeout**
Sequence 3, no answer yet ⓘ
- Ping statistics:**
3 transmitted, 0 received, 100% packet loss, time 12090 ms

If the ping times out, check the communication between the airborne and ground units of the video transmission system. If the network responds, verify the camera's connection to the airborne unit and ensure that the supply voltage to the airborne unit

REEBOT

is within the normal range.

On a Windows Device

1. Press Win + R to open the Run dialog, then type cmd.

Network Communication Normal

```
Microsoft Windows [Version 10.0.26100.2894]
(c) Microsoft Corporation. All rights reserved.

C:\Users\Siyi>ping 192.168.144.25

Pinging 192.168.144.25 with 32 bytes of data:
Reply from 192.168.144.25: bytes=32 time=4ms TTL=64
Reply from 192.168.144.25: bytes=32 time=1ms TTL=64
Reply from 192.168.144.25: bytes=32 time=1ms TTL=64
Reply from 192.168.144.25: bytes=32 time=2ms TTL=64

Ping statistics for 192.168.144.25:
    Packets: Sent = 4, Received = 4, Lost = 0 (0% loss),
    Approximate round trip times in milli-seconds:
        Minimum = 1ms, Maximum = 4ms, Average = 2ms
```

Network Communication Failure

```
C:\Users\Siyi>ping 192.168.144.25

Pinging 192.168.144.25 with 32 bytes of data:
Request timed out.
Request timed out.
Request timed out.
Request timed out.

Ping statistics for 192.168.144.25:
    Packets: Sent = 4, Received = 0, Lost = 4 (100% loss),
```

2. Ping the camera's IP address 192.168.144.25 and press Enter to verify network connectivity. If the network responds, check that the RTSP address entered in the media player is correct, or try using a different player.

REEBOT



3. If the ping times out, check the communication between the airborne unit and the ground unit of the video transmission system. If the network responds, verify the camera's connection to the airborne unit and ensure that the supply voltage to the airborne unit is within the normal range.
4. If network communication still fails, check whether the ground unit and Windows computer are communicating properly. If the ping times out, verify the computer's network connection and ensure that the computer can obtain an IP address correctly.

 **Note:** If the issue cannot be resolved after performing the above steps, collect all relevant information from the troubleshooting process and contact your local distributor or technical support for further assistance.

Chapter 6: Laser Rangefinder

The MT11 Mini Quad-Sensor AI Gimbal Payload is equipped with a high-precision laser rangefinder, capable of measuring distances from 5 to 1200 meters.



Laser Rangefinder Precautions

1. Keep the device away from water and other liquids, and avoid dust or contamination. Ensure that the optical glass surfaces (transmit and receive windows) remain clean.
2. Avoid measuring objects with low surface reflectivity under strong light conditions, as this may affect measurement accuracy.
3. Do not measure targets within 5 meters, especially highly reflective objects such as glass or polished metal surfaces.
4. Avoid multiple rangefinder modules facing each other at close range, as direct exposure to high-energy laser sources may damage the receiver.
5. This product is classified as Class 3R. Follow all safety precautions and never look directly into the laser.

REEBOT

6. Rapid temperature changes, as well as adverse weather conditions such as rain, snow, fog, haze, or dust, may affect measurement performance.

Factors Affecting Rangefinder Performance and Accuracy

1. **Target Reflectivity:** Generally, the higher the target's reflectivity, the better the rangefinder performance and response speed. For example, a medium-reflectivity target may be measurable up to 1200 meters, while a low-reflectivity target may only be measurable up to 600 meters.
2. **Measurement Angle:** The closer the laser beam is perpendicular to the target surface, the better the rangefinder performance and response speed. Deviations from perpendicular reduce measurement capability.

Chapter 7: Thermal Imaging

The MT11 supports a wide range of thermal imaging features, including multiple color palettes, multiple temperature measurement modes, thermal raw data storage, thermal image environmental correction, thermal gain mode switching, AI-powered thermal super-resolution, and manual thermal shutter calibration.

Manual Thermal Shutter Calibration: Used to eliminate image noise and reduce temperature measurement drift caused by prolonged operation of the thermal camera.

7.1 Thermal Imaging Temperature Measurement

The MT11 supports multiple temperature measurement modes, including full-image measurement, point measurement, and box measurement.

7.1.1 Point Measurement

In the UniGCS APP, switch to the thermal imaging view. Tap any point on the image to display the temperature at that specific point.

Point Measurement

REEBOT



7.1.2 Box Measurement

In the thermal imaging view, draw a selection box to enter box measurement mode.

The mode displays the highest and lowest temperatures within the selected area.

Box Measurement



At the lower-left corner of the area measurement box, there are three buttons: the first

REEBOT

cancels the measurement, the second activates global measurement, and the third sets the temperature alarm.

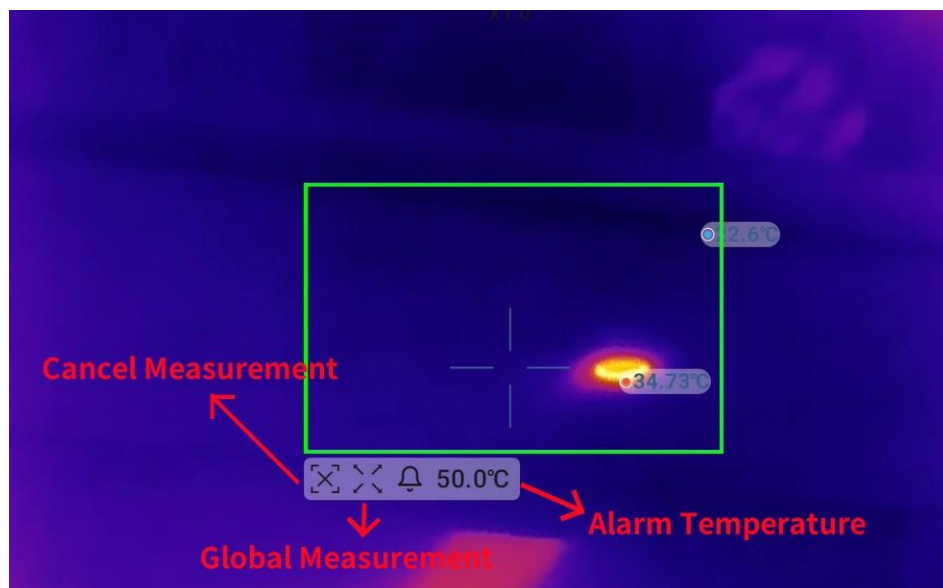

7.1.3 Full-Image Measurement

Tap the global measurement button to enter global measurement mode. The highest and lowest temperatures within the current frame are displayed.

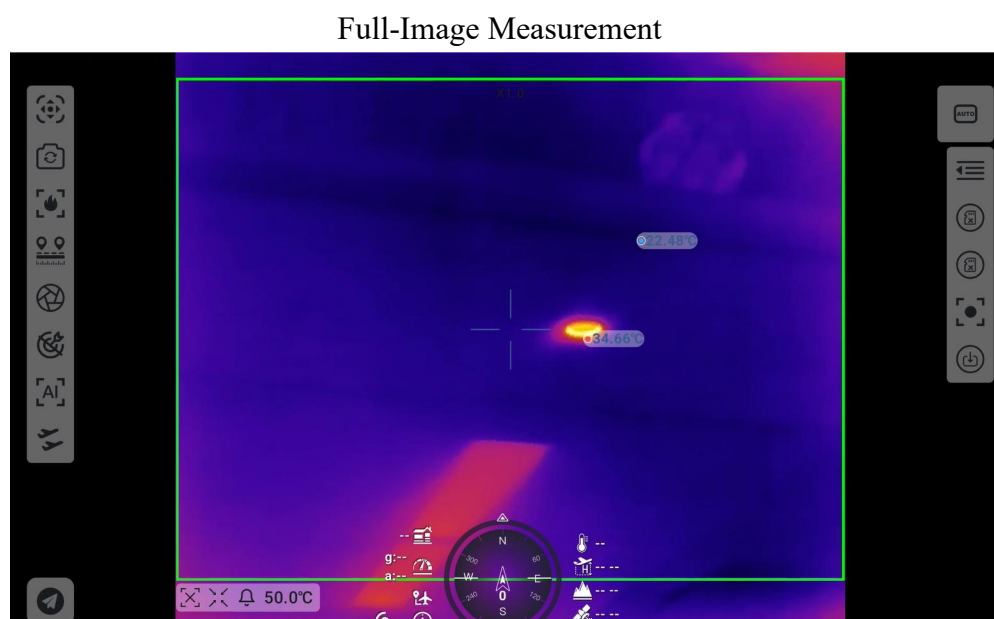

REEBOT

During area or global measurement, the temperature alarm can be displayed. Tap the alarm temperature to set the threshold for high-temperature alarms.

High-Temperature Alarm

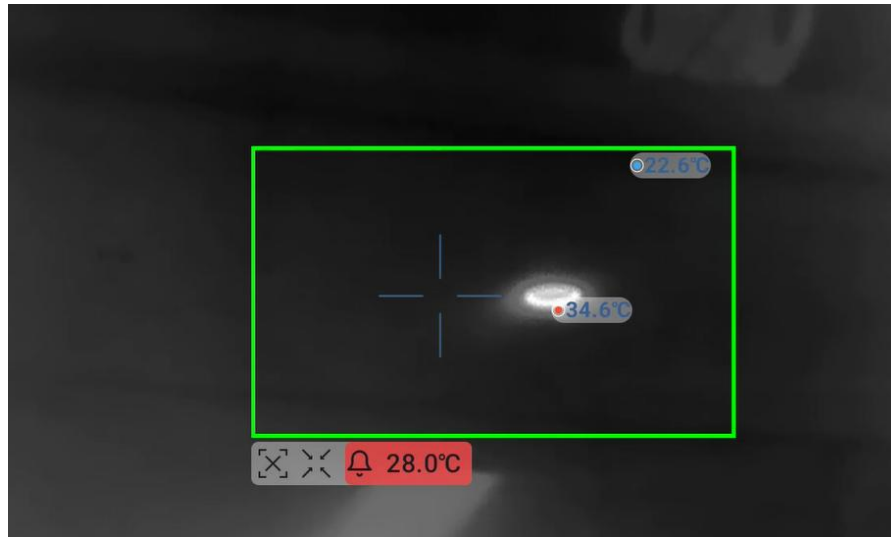

7.2 Thermal Imaging Environmental Calibration

The thermal imaging environmental calibration function enhances the accuracy of temperature measurement in thermal imaging.

Purpose of Environmental Calibration: Thermal imaging sensors determine object temperature by detecting infrared radiation emitted from the surface. However, environmental factors can significantly affect accuracy. Environmental Calibration compensates for these external interferences by applying environmental parameters—such as target distance, emissivity, ambient humidity, atmospheric temperature, and reflected temperature—so that the corrected thermal data is closer to the object’s true temperature.

Parameter Description

REEBOT

Target Distance: The distance between the gimbal's thermal imaging lens and the object under observation, measured in meters (m).

Target Emissivity: The ratio of an object's thermal radiation emission capability to that of an ideal blackbody (perfect emitter). Dimensionless, ranging from 0 to 1. Emissivity is influenced by material properties, surface roughness, temperature, and wavelength.

Ambient Humidity: The water vapor content of the measurement environment, expressed as a percentage (%).

Atmospheric Temperature: The actual air temperature in the measurement environment, measured in degrees Celsius (°C).

Reflected Temperature: The equivalent temperature value of infrared radiation reflected from surrounding objects and surfaces, measured in degrees Celsius (°C).

Operation Guide

In the Thermal Imaging Environmental Calibration panel, select Set Parameters to enter the configuration interface (see figure below). The yellow box highlights the Set Parameters option.

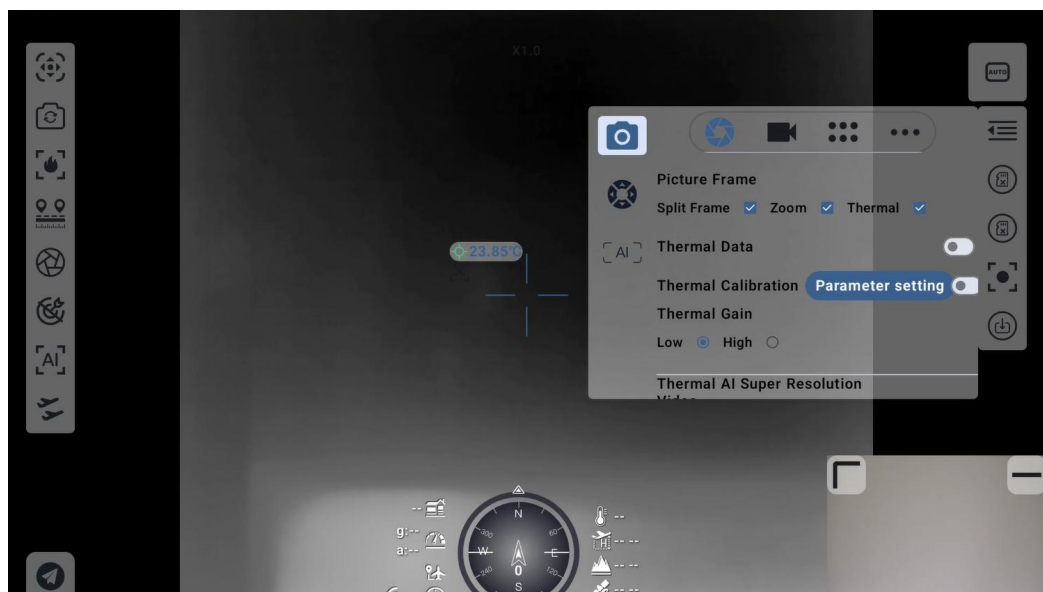

REEBOT

In the setup interface, enter the Target Distance and Target Emissivity in the input fields. Click Apply to save the settings, or click Cancel to close the interface without saving.

If additional parameters need to be configured, click the “More Parameters” button to enter the advanced parameter settings interface.

To restore default values, click the “Default Values” button. The input fields will revert to the factory defaults. If the operator wishes to save the newly entered parameters, click the “Set” button. If the operator does not intend to save the changes, click the “Cancel” button to exit the interface.



Once the interface is closed, toggle the Calibration Switch to enable the feature. When calibration is active, spot temperature and area temperature measurements will be automatically corrected. The active calibration status is indicated in the red box in the figure below.

REEBOT

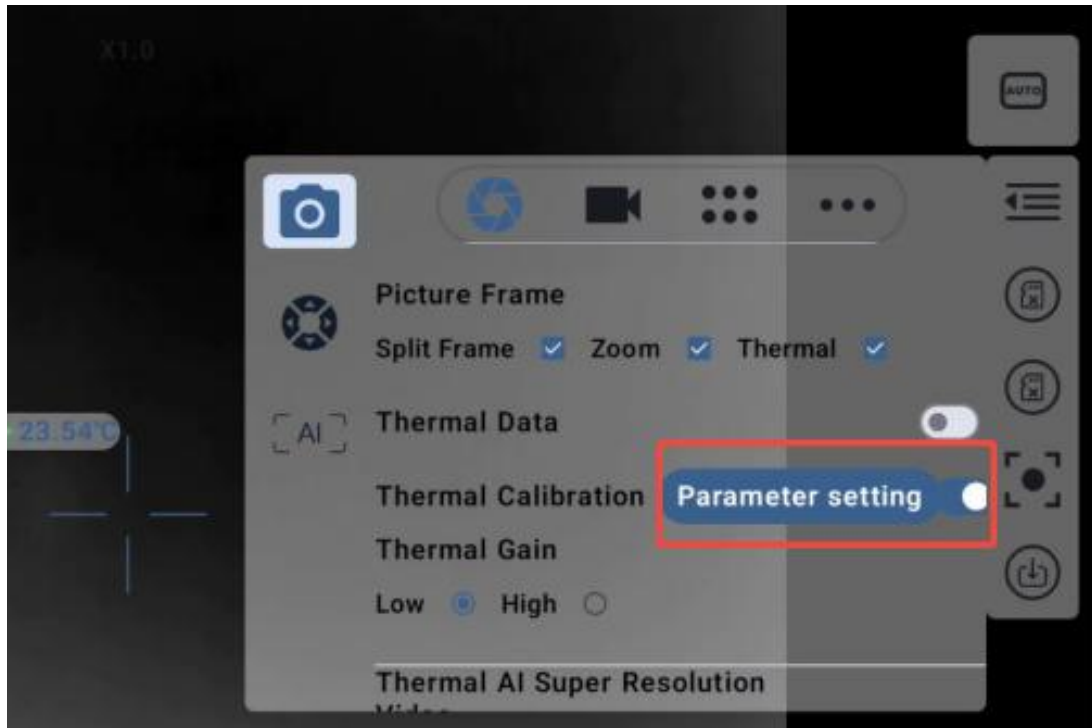

Additional settings are shown in the figure below:

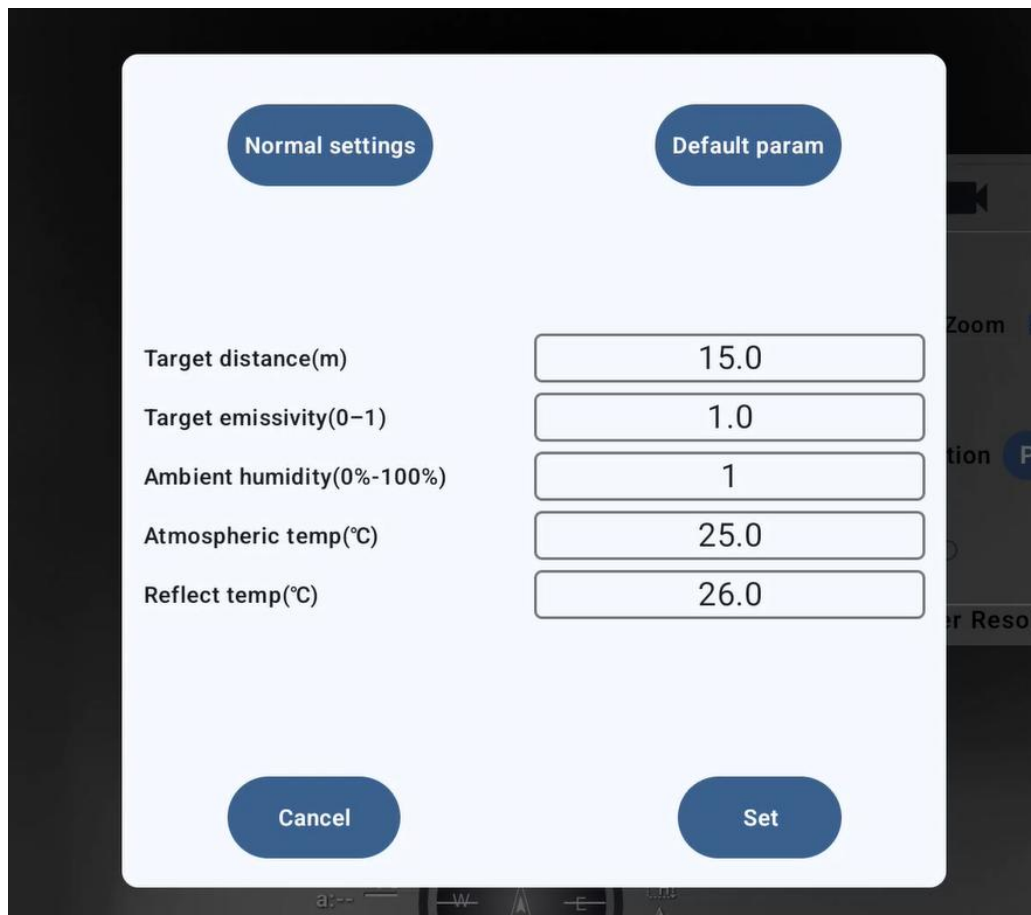

Note: In most use cases, adjusting only Target Distance and Target Emissivity is sufficient. Other parameters have minimal impact on measurement accuracy and can generally remain at their default values.

7.3 Pseudo-Color Mode Settings

The MT11 supports nine pseudo-color modes. By applying different color palettes, operators can enhance thermal image interpretation, making it easier to distinguish heat distribution under various operating environments.

Supported Pseudo-Color Modes

REEBOT

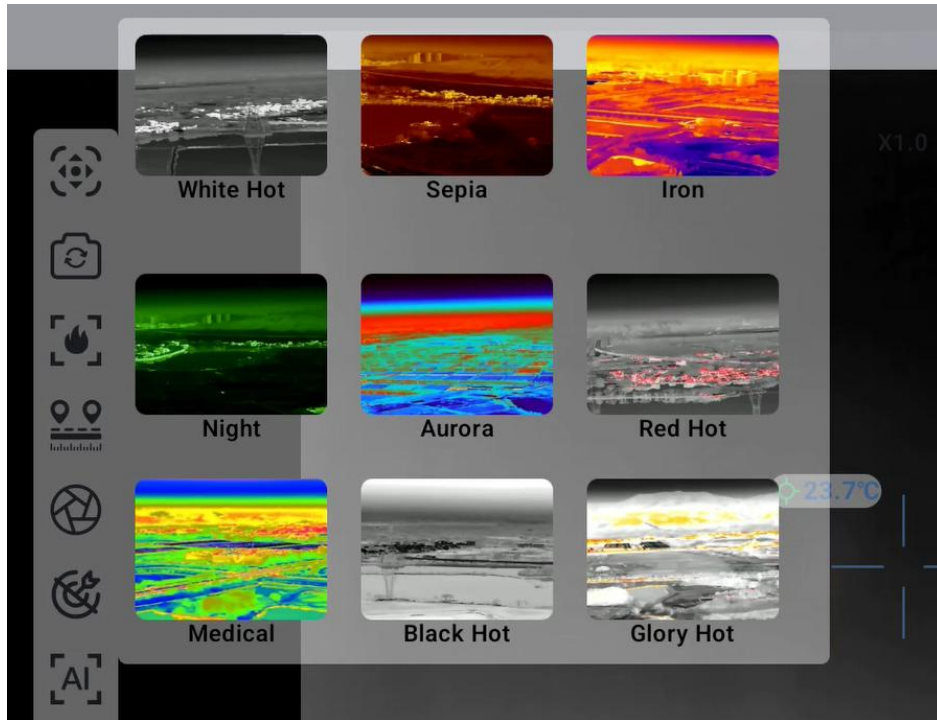

White Hot



REEBOT

Sepia



Iron

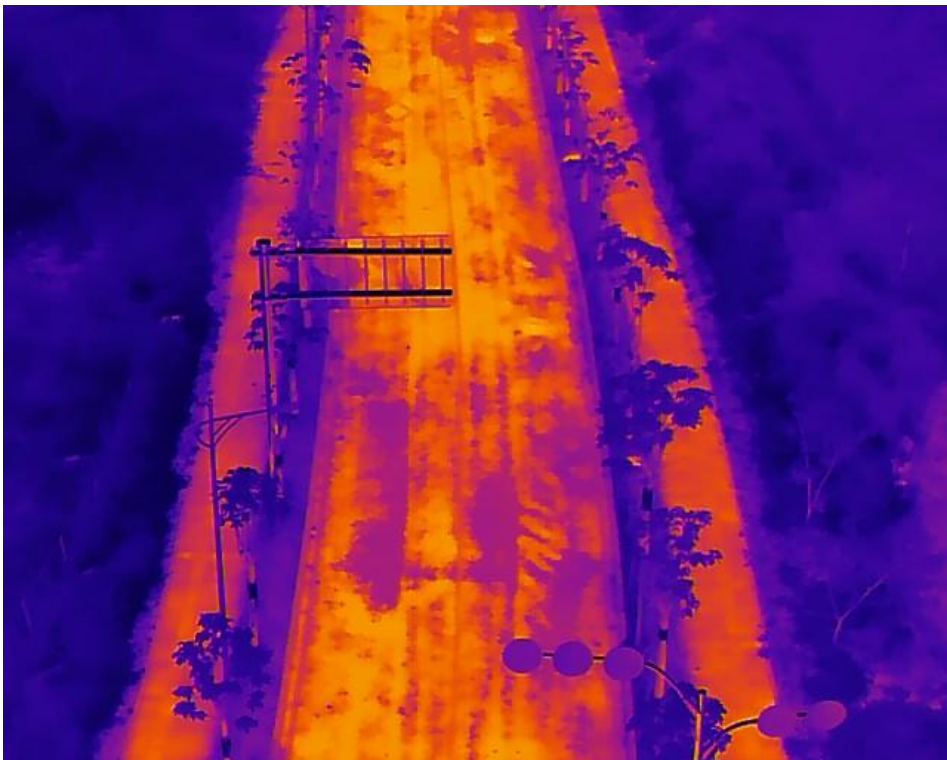

REEBOT

Night



Aurora

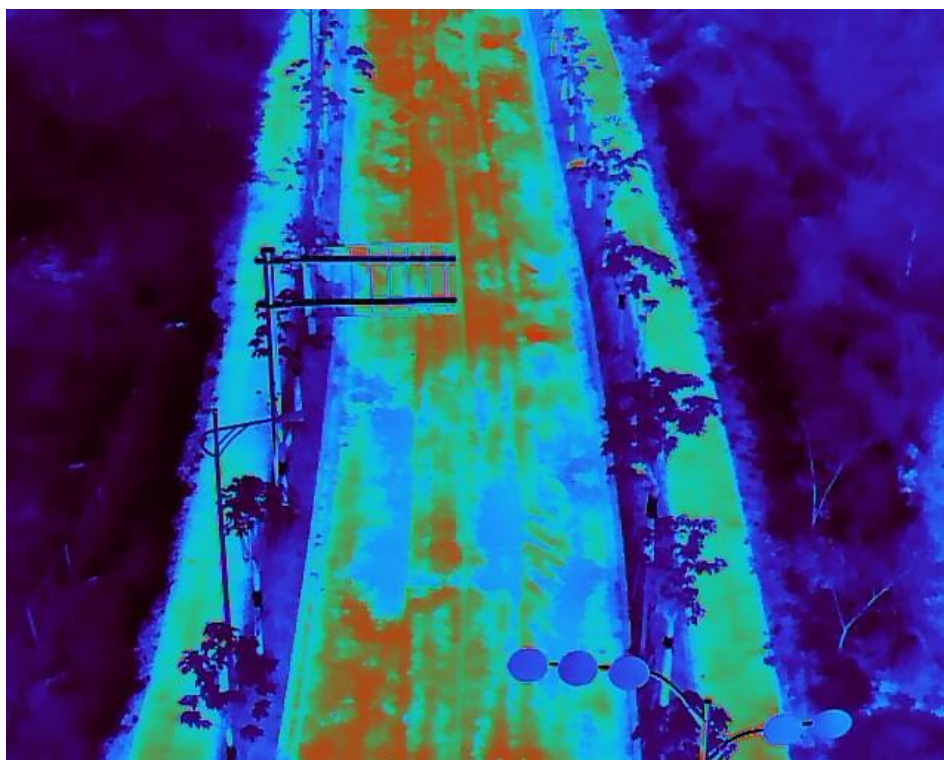

REEBOT

Red Hot



Medical

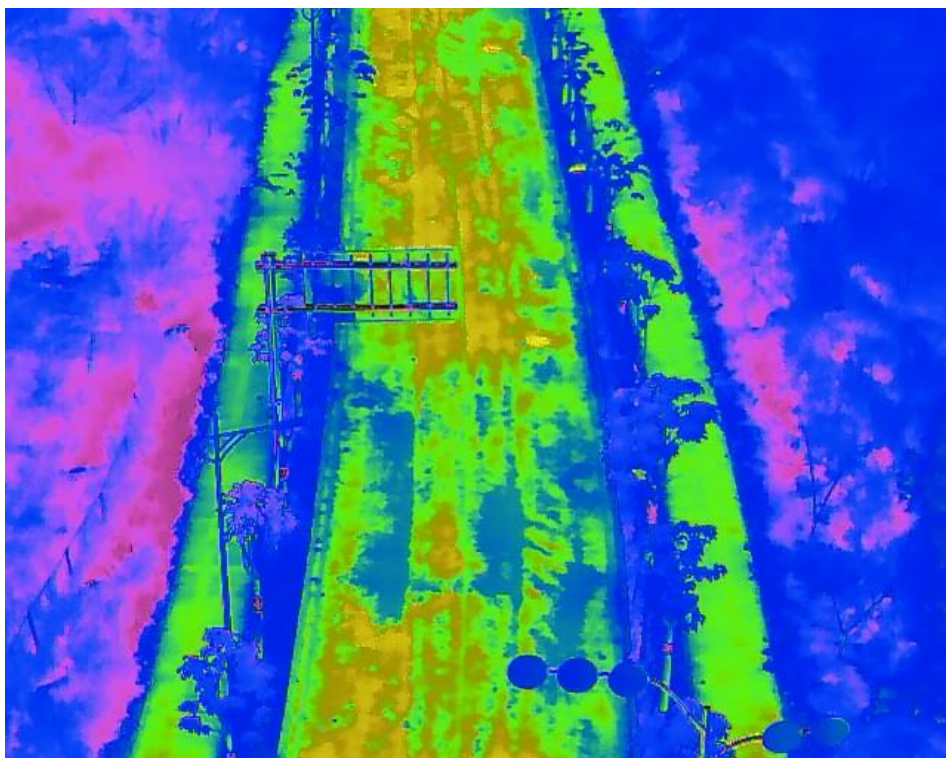

REEBOT

Black Hot



Glory Hot



7.4 Thermal Imaging AI Super-Resolution

The MT11 thermal module supports AI super-resolution enhancement, providing up to 2× video super-resolution and up to 4× photo super-resolution.

2× Video Super-Resolution: When enabled, the thermal video recording resolution increases from 640×512 to 1280×1024 .

Photo Super-Resolution: When enabled, still image resolution can be enhanced from 640×512 to 1280×1024 or 2560×2048 .

Enabling Thermal AI Super-Resolution can improve the image quality of the thermal video stream.

Without AI Super-Resolution



4× AI Super-Resolution



REEBOT

7.5 Thermal Imaging Gain

The thermal camera supports High Gain and Low Gain modes to accommodate different temperature measurement ranges.

High Gain: -20°C to +150°C ($\pm 2^\circ\text{C}$)

Low Gain: 0°C to +550°C ($\pm 5^\circ\text{C}$)

7.6 Thermal Imaging Raw Data

The thermal camera supports saving and exporting raw data (BIN files).

Image Only: Outputs thermal video stream only.

Enable the Raw Thermal Data option, select the Thermal View when taking photos, and click Capture to save the raw thermal data file with temperature information to the memory card.

Thermal Imaging Raw Data Calculation (For Reference Only):

The raw thermal data file size is $640 \times 512 \times 2 = 655,360$ bytes. Each pixel occupies 2 bytes in little-endian format.

Example: Converting a single pixel raw value to Celsius

1. Raw value of a pixel: 7C 4B
2. Convert hex to binary: 01111100 01001011
3. Set the two leftmost bits to 0: 00111100 01001011
4. Convert binary back to hex: 3C 4B
5. Convert to big-endian: 4B 3C
6. Convert hex to decimal: 19260
7. Apply formula: Temperature ($^\circ\text{C}$) = $19260 / 64 - 273.15 = 26.85^\circ\text{C}$

Chapter 8: UniGCS APP

The UniGCS APP is designed around an open ecosystem, aiming to provide a highly compatible and extensible platform. Support for an open ecosystem fosters the development of innovative applications, further expanding operational scenarios and enabling operators to fully leverage technological capabilities.



Note: Most functions of the MT11 require the use of the UniGCS APP.

8.1 UniGCS APP Main Interface Overview

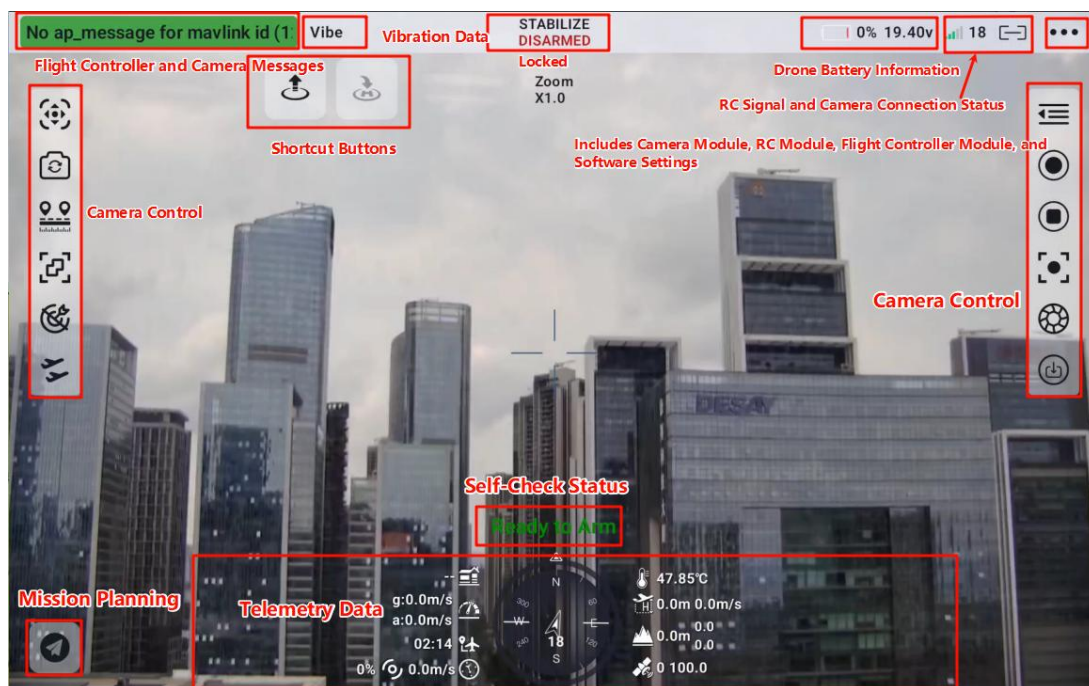

Function Icons

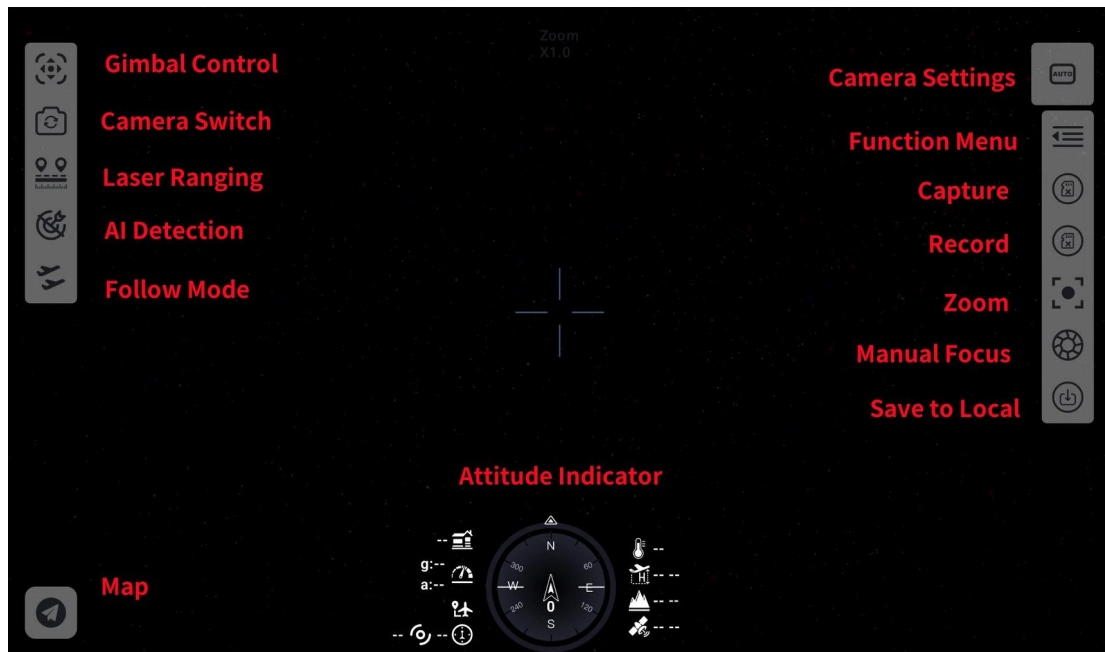

On the left side of the main interface, from top to bottom, the icons are: Gimbal Control, Camera View Switch, Laser Rangefinder Toggle, AI Recognition Toggle, Follow Mode, and Map.

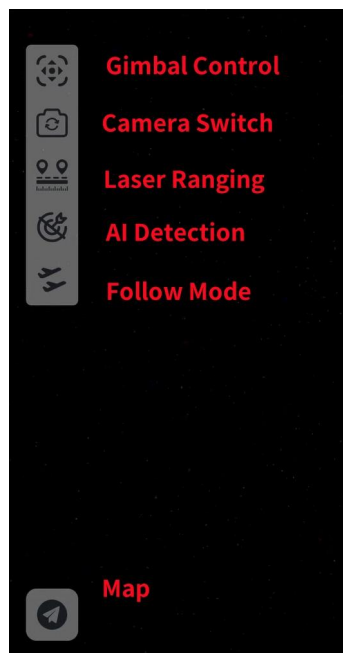

REEBOT

On the right side of the main interface, from top to bottom, the icons are: Camera Parameter Adjustment, Function List, Photo Capture, Video Record Toggle, Zoom Control, Manual Focus, and Local Storage Save.

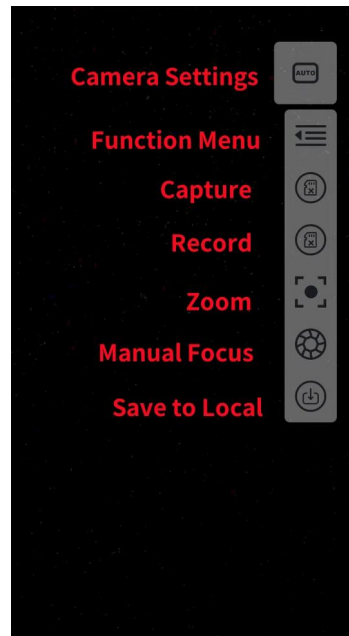

8.2 Function List Overview

The Function List includes basic functions, video settings, gimbal settings, and other options.

√ Basic Functions:

MT11 provides a comprehensive set of basic functions, including:

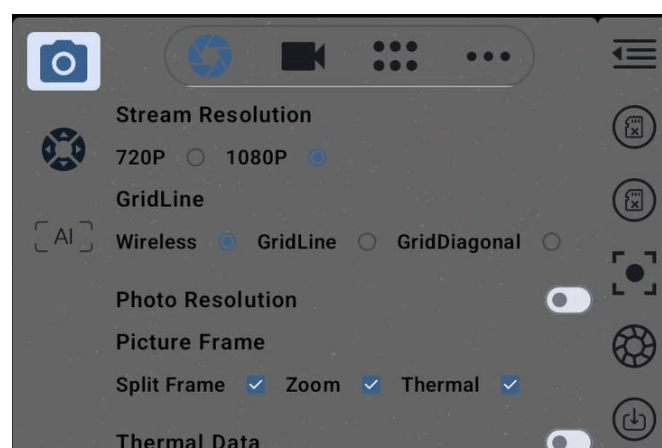

REEBOT

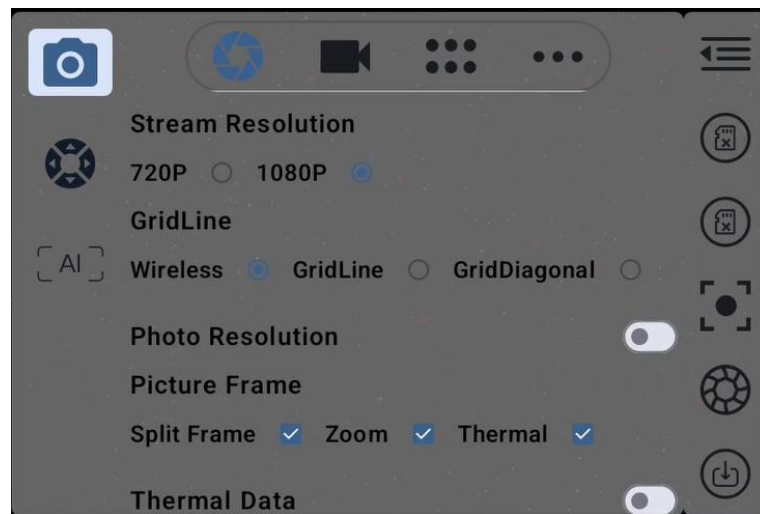

Video Settings and Stabilization: Configure video recording and enable electronic image stabilization (EIS).

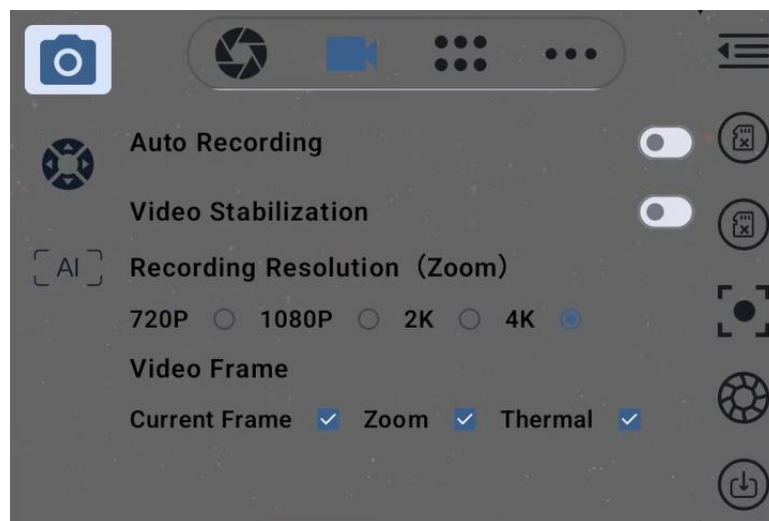

REEBOT

S.BUS Control Channel Setup:

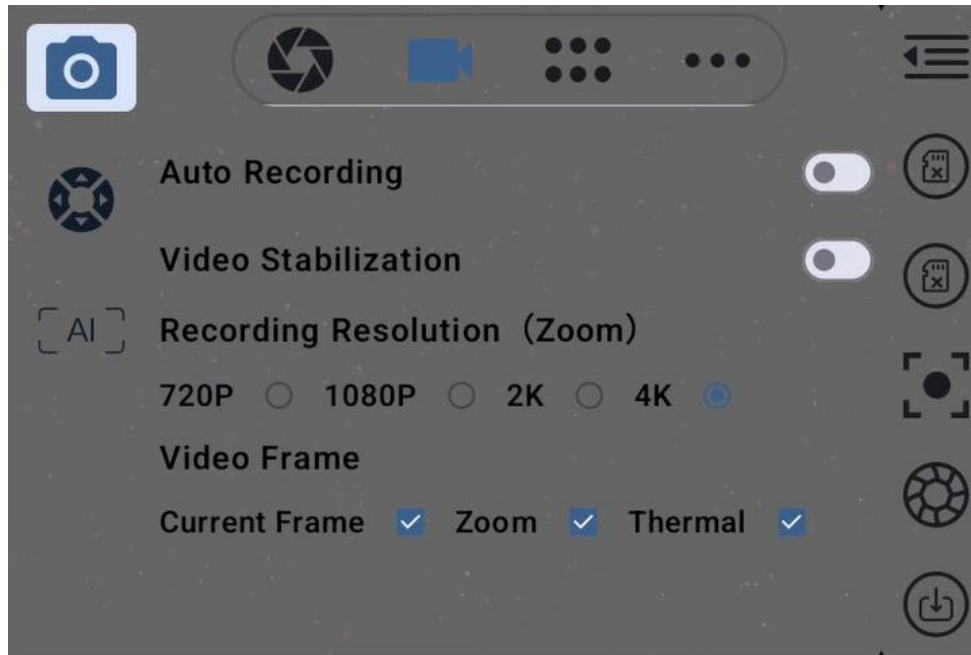

IP Configuration: Save parameters; the confirmation interface only displays modified parameters.

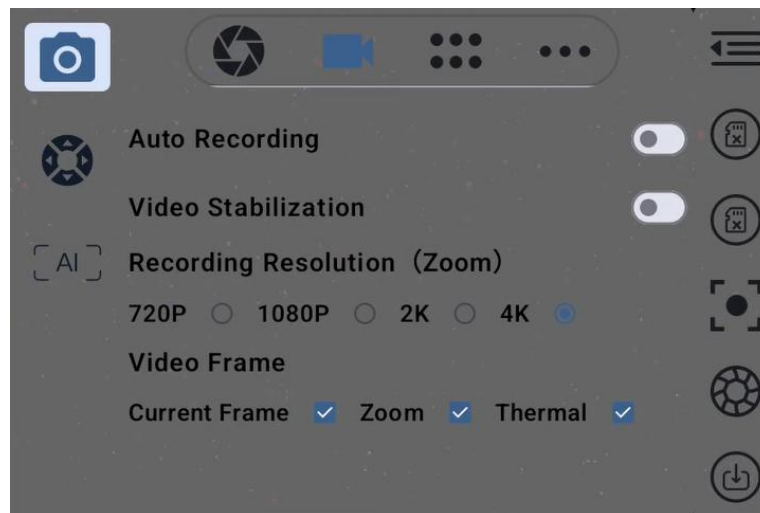

Gimbal Operation Modes: MT11 supports three gimbal modes: Lock, Follow, and FPV.

REEBOT

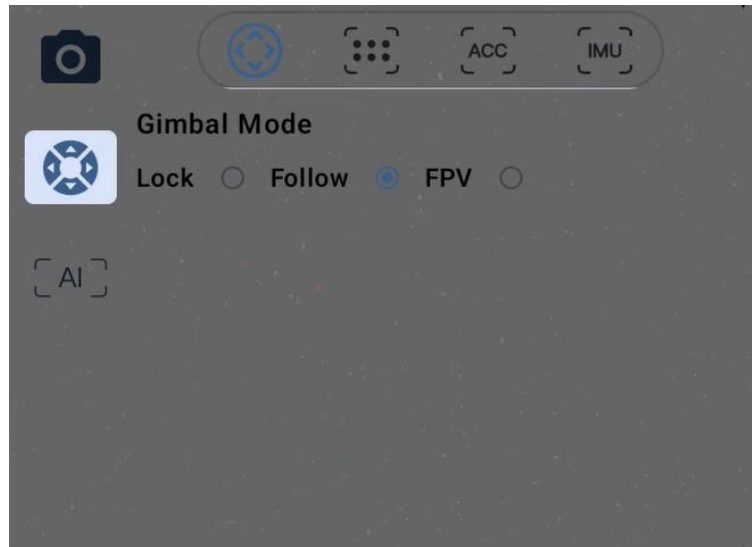

AI Settings: Configure AI recognition, AI tracking, and related options.

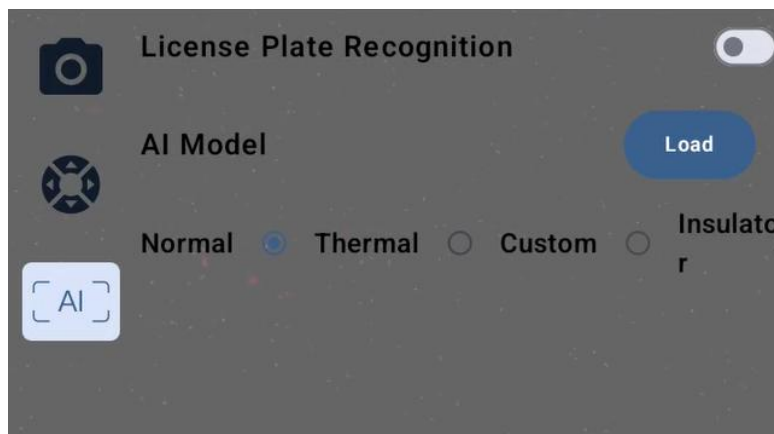

✓ Camera Address Settings:

Tap the three-dot icon in the top-right corner of the main interface to access the camera address settings. Supports dual-stream output from MT11, including the main stream and substream. The Scan button detects pods on the same network segment as the link device. The Upgrade button is used for firmware updates.

REEBOT

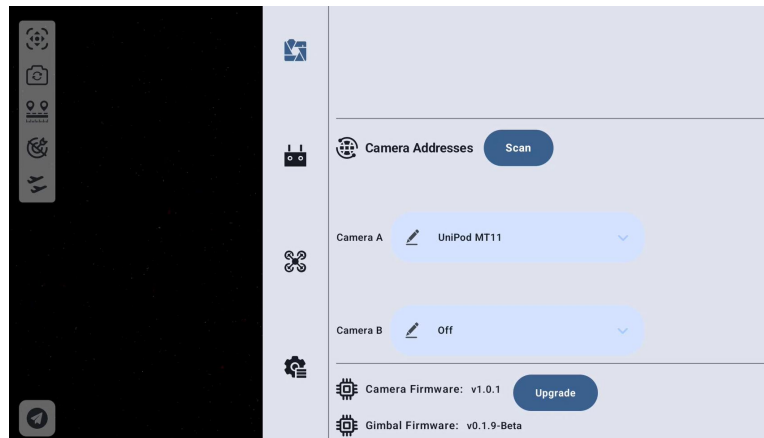

✓ Remote Controller Settings

The UniGCS APP provides comprehensive configuration options for the remote controller.

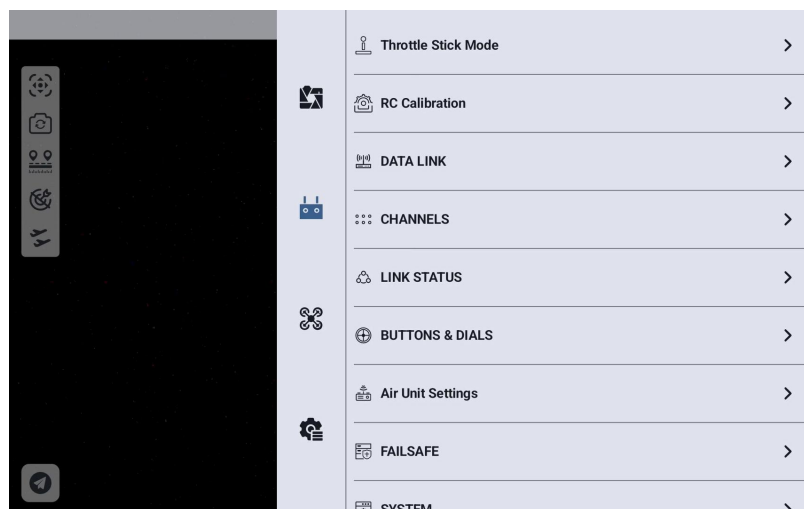

 Note: Features and functionality are subject to continuous updates. Actual interface content and functionality may vary. Please refer to the latest version. Updates may be made without prior notice.

Chapter 9: MT11 Firmware Upgrade and Accelerometer Calibration

The MT11 supports two firmware upgrade methods: via TF card or through the APP for online upgrade. Both methods use the same firmware package. The upgrade process consists of two steps: first the gimbal firmware, then the camera firmware. Before performing the upgrade, ensure the device is displaying video output properly.

√ TF Card Firmware Upgrade

Before performing a TF card firmware upgrade, prepare a TF card formatted as Fat32 or exFAT.

1. Download the latest firmware package (including both gimbal and camera firmware) from the official website and place it in the root directory of the TF card. Do not perform any other operations on the TF card.
2. Insert the TF card into the MT11 slot, power on the device, and wait approximately five minutes for the device to reboot.

 **Note:** During the upgrade, the gimbal will lose stabilization. First, the gimbal firmware will be upgraded; once completed, stabilization will return to normal. Then, the camera firmware will be upgraded, after which the device will resume normal video output.

√ APP Online Firmware Upgrade

When performing a firmware upgrade via the APP, store the firmware in the local files of the remote controller. Before upgrading, ensure that all relevant bitrate-enhancing settings on the transmission link are enabled (e.g., bitrate enhancement mode).

REEBOT

1. Access the APP settings interface to locate the upgrade button.

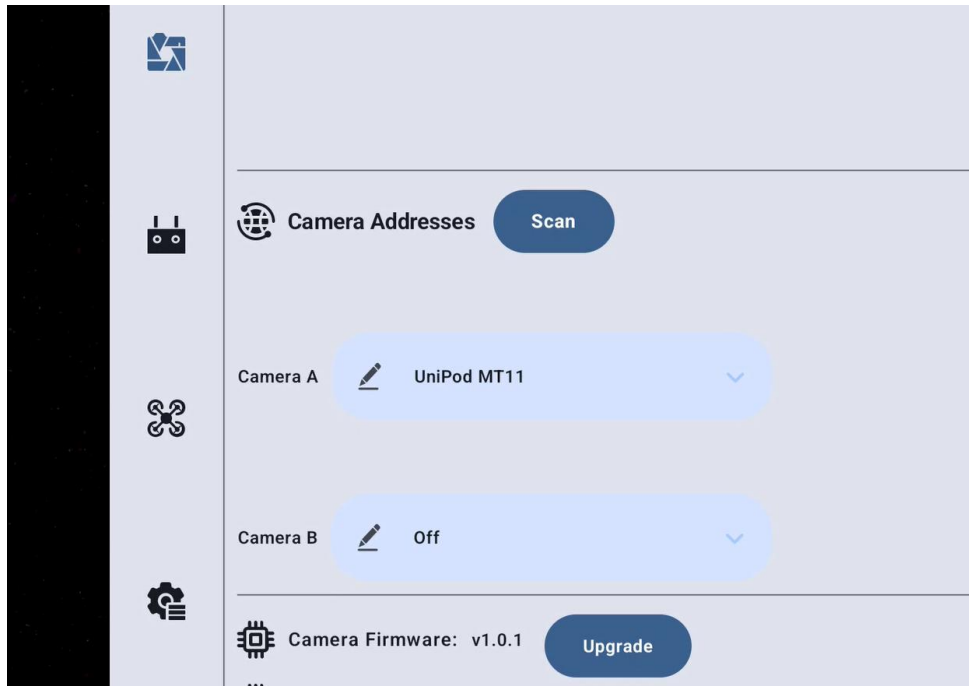

2. Tap the upgrade button, select the firmware to be upgraded, and enter the upgrade confirmation interface.

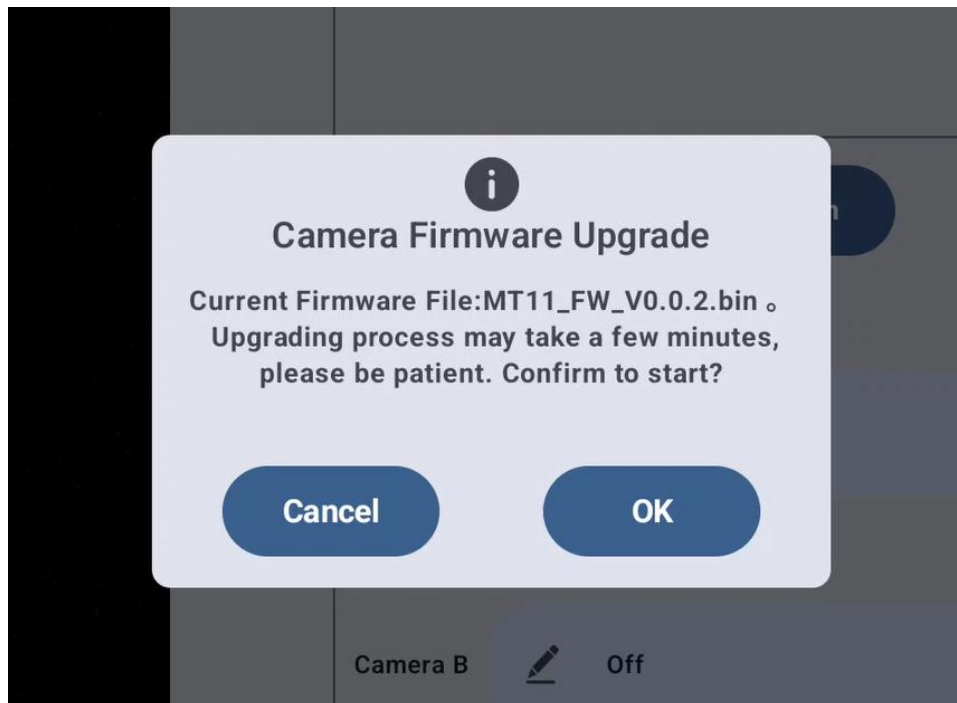

3. After confirming the firmware is correct, tap “Confirm” to start the transfer. The first progress bar represents the gimbal firmware transfer, and the second

REEBOT

represents the camera firmware transfer. The two firmware packages will be transferred sequentially. During gimbal firmware upgrade, stabilization will be temporarily disabled; stabilization will resume once the upgrade is complete.

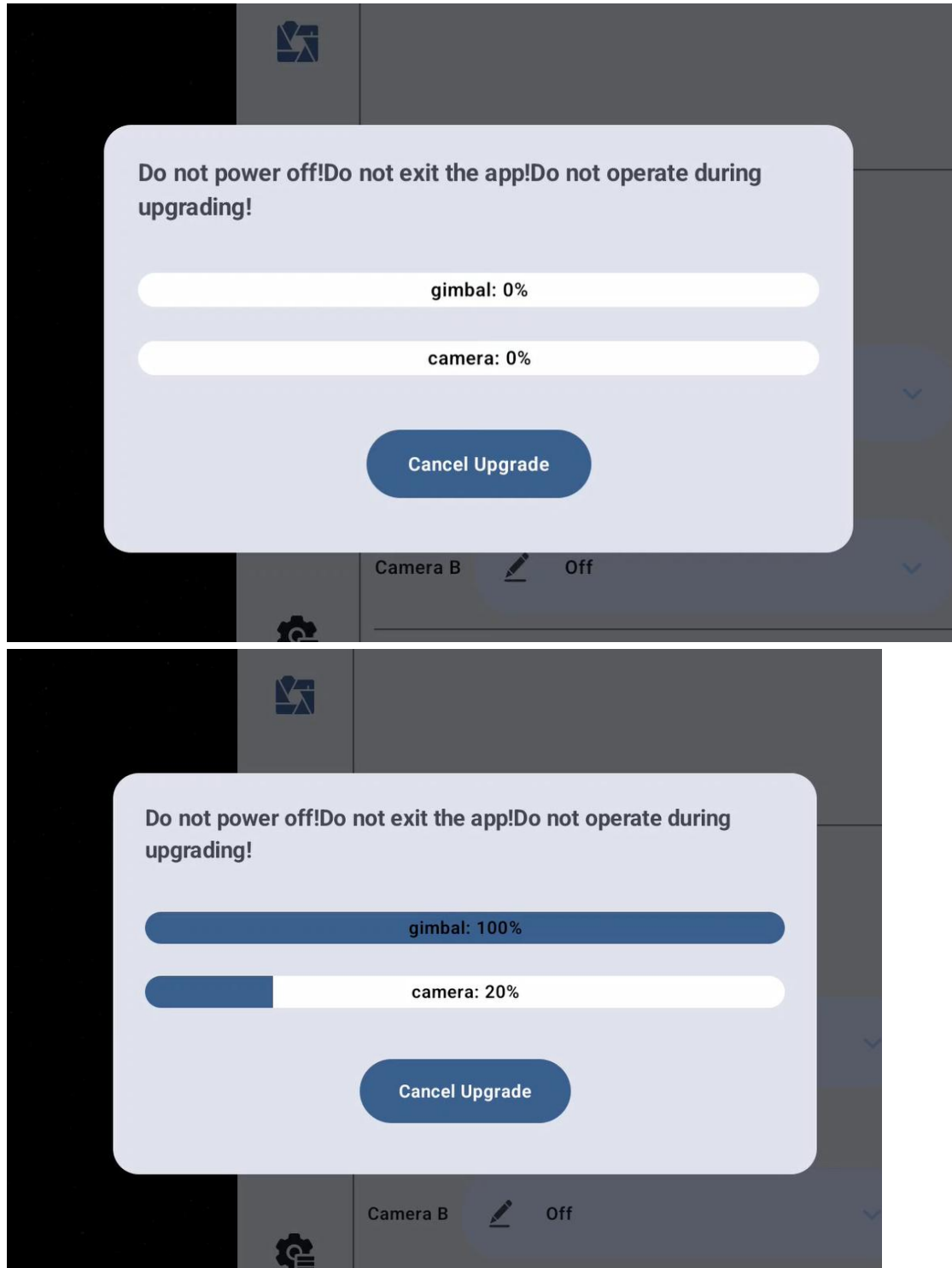

REEBOT

4. After the file transfer is complete, a message will indicate the upgrade is finished, and the interface will return to the upgrade screen.

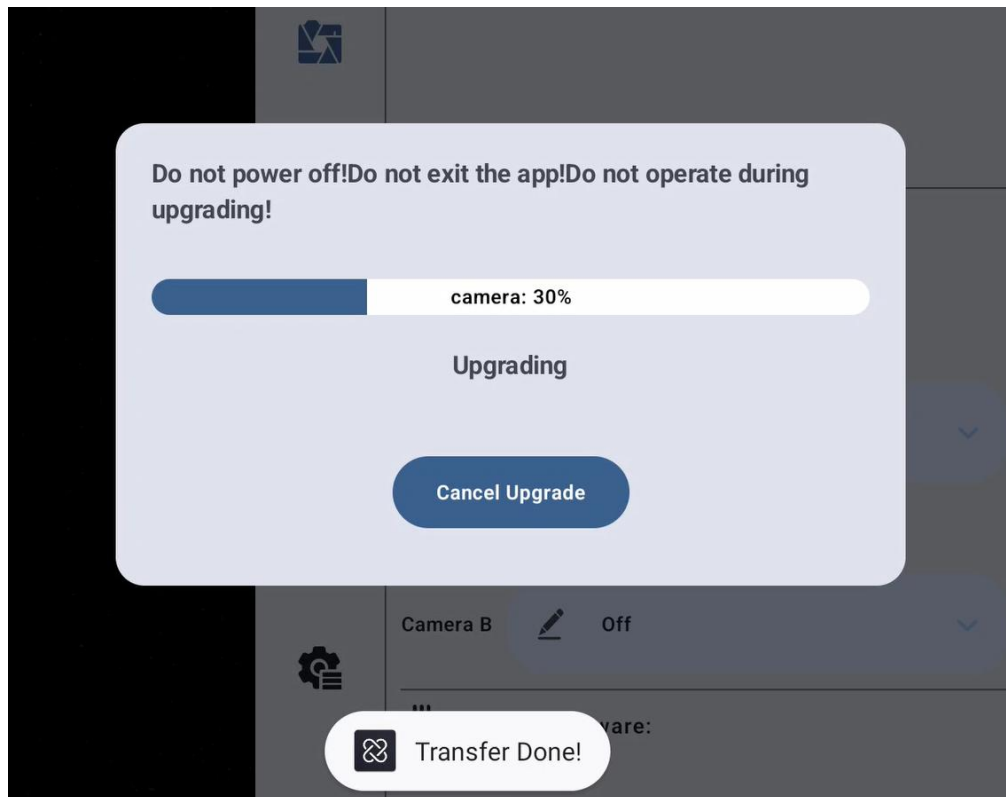

5. When the upgrade is fully completed, the firmware version can be checked. A correct firmware version indicates the upgrade was successful.

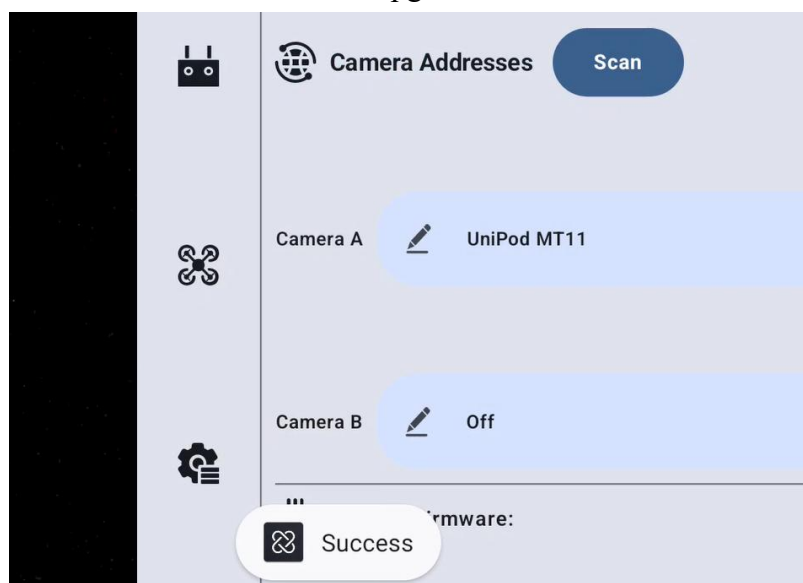

Note: Do not power off the device during the upgrade. Do not exit the APP or

REEBOT

force-close it during the process.

If the device fails to display video or encounters any abnormal conditions during the upgrade, please retry the upgrade. If the issue persists, restart the device and check whether it returns to normal or attempt the upgrade again.

If the problem remains unresolved after these steps, please contact official technical support and provide details of the previous operations for troubleshooting.

Chapter 10: After-Sale Policy

10.1 Scope of Application

1. This after-sales policy applies only to products purchased through authorized official channels from Reebot Robotics (Shenzhen) Co., Ltd. (hereinafter referred to as "Reebot Robotics").
2. Effective Date: This after-sales policy is effective from December 4, 2024. All products purchased after this date are subject to this policy, and any previous after-sales policies will be automatically nullified.
3. Additional Applicability: The after-sales policy is subject to the information published on the official website.

10.2 Return Service

10.2.1 Timeframe and Conditions

Returns can be requested within 7 calendar days from 00:00 the day after receipt of goods, if the product is found to have performance issues that are not caused by human damage.

10.2.2 Situations Not Eligible for Return

1. Customized or personalized products (e.g., products made according to customer specifications), once produced or shipped, are not eligible for return.
2. Return requests made after 7 calendar days from the day after receipt of goods.

REEBOT

3. Products returned with missing parts or damages caused by human factors.
4. Returns without valid proof of purchase or invoices, or if invoices are tampered with or forged.
5. Product damage caused by issues not related to product quality (e.g., collision, burning, improper modifications, exposure to foreign materials such as water, oil, sand, incorrect installation, or failure to follow the manual).
6. Removal or alteration of labels, machine serial numbers, waterproof marks, anti-counterfeit labels, etc.
7. Damage caused by unavoidable factors such as fire, water, lightning, or traffic accidents.
8. Failure to send back the item within 7 calendar days after confirming the return with Reebot Robotics.
9. Any other conditions not meeting the return criteria.

10.3 Exchange Service

10.3.1 Timeframe and Conditions

Exchanges can be requested within 15 calendar days from 00:00 the day after receipt of goods, if the product is damaged during shipping (with valid shipping damage proof), does not match the original description, or has performance issues that are not caused by human damage.

REEBOT

10.3.2 Situations Not Eligible for Exchange

1. Exchange requests made after 15 calendar days from the day after receipt of goods.
2. Exchange products missing parts or damaged by human factors.
3. Failure to provide valid proof of purchase or invoices for exchange.
4. Product does not have quality issues upon inspection by Reebot Robotics' technical support department.
5. Product issues caused by human factors, such as improper modifications, exposure to foreign materials, incorrect installation, or failure to follow the manual.
6. Removal or alteration of labels, serial numbers, waterproof marks, anti-counterfeit labels, etc.
7. Damage caused by unavoidable factors such as fire, water, lightning, or traffic accidents.
8. Failure to send back the item within 7 calendar days after confirming the exchange with Reebot Robotics.
9. Failure to provide valid shipping damage proof for claims related to transportation damage.
10. Any other conditions not meeting the exchange criteria.

10.4 Warranty Service

10.4.1 Warranty Period and Conditions

If the product malfunctions due to non-human causes during the warranty period, and

REEBOT

there are no unauthorized repairs, modifications, or installation of non-official parts, and you can provide valid proof of purchase, the product will be eligible for warranty service.

10.4.2 Warranty Start Date

If valid proof of purchase (e.g., invoice) cannot be provided, the warranty start date will be 60 days after the production date shown on the product (unless otherwise specified by Reebot Robotics).

10.4.3 Warranty Period

1. Main products such as gimbals, cameras, link products, propulsion systems, flight control systems: 12 months.
2. Smart batteries (less than 200 charge cycles): 12 months.
3. Consumables such as lens protection caps: 3 months.
4. Propellers and other consumables: No warranty service provided.

10.4.4 Situations Not Covered by Warranty

1. Damage caused by human factors such as collision, burning, or flying loss.
2. Damage caused by unauthorized modifications, disassembly, or repairs.
3. Damage caused by improper installation, use, or operation according to the manual.
4. Damage caused by unauthorized repairs or assembling parts.

REEBOT

5. Damage caused by improper usage of batteries, chargers, or circuit modifications not recommended by Reebot Robotics.
6. Damage from improper flying or photography techniques as per the product manual.
7. Damage from operating in harsh environments (e.g., high winds, rain, sandstorms).
8. Damage from operating in areas with strong electromagnetic interference (e.g., mining areas, transmission towers, high-voltage lines, substations).
9. Damage caused by interference from other wireless devices (e.g., transmitters, video transmission signals, WiFi interference).
10. Damage caused by exceeding the safe takeoff weight.
11. Damage caused by flying with aged or damaged components.
12. Damage caused by using non-Reebot Robotics certified third-party components.
13. Damage due to low battery levels or using faulty batteries.
14. Altered or tampered product labels, serial numbers, or factory tags.
15. Failure to send the product back within 7 calendar days after confirming the warranty service with Reebot Robotics.
16. Any other situations not covered by the warranty.

10.5 General After-Sales Terms

10.5.1 Repair Locations and Methods

Customers can find repair center information on our official website or by contacting customer service. We also offer mail-in repair services.

REEBOT

10.5.2 Software Services

We provide software updates for product performance optimization and bug fixes. However, software issues may affect warranty eligibility (e.g., software failures caused by non-official software).

10.5.3 Data Privacy and Security

We are committed to ensuring data privacy and security during after-sales services. However, operators are responsible for backing up their data in advance, as repairs may result in data loss.

10.5.4 Shipping Costs

1. Mainland China: For products under warranty, the customer will pay for the shipping cost to send the product to Reebot Robotics, and Reebot Robotics will cover the return shipping cost after repairs. For products not covered by warranty, the customer is responsible for both shipping costs.
2. Outside Mainland China: Shipping costs for both directions are the customer's responsibility, regardless of warranty status. Please contact local dealers for consolidated returns to save on shipping and banking fees.
3. Customers are responsible for shipping costs related to software upgrades.
4. When returning items for repair, please choose reputable courier services (e.g., DHL, FedEx, UPS for international customers), and contact our after-sales department once the item has been shipped for timely processing.

REEBOT

10.5.5 Other Fees

1. If a product needs to be sent back for repair, Reebot Robotics will cover testing, material, and labor fees if the issue is covered under warranty.
2. If the product is not covered under warranty, customers can choose to pay for repairs or have the original product returned.
3. For products outside warranty, we may charge fees for testing, parts replacement, and labor.
4. If we cannot contact you for an extended period, or if the product is returned undelivered or refused by the recipient, Reebot Robotics will store the product for 60 days from the last contact date. A storage fee of 150 RMB per day will be charged after the storage period, and the product will be disposed of if the storage fee exceeds the product's residual value.
5. Any customs duties or fees for international returns must be paid by the customer.

10.5.6 Other After-Sales Notes

1. Please do not send back batteries with severe damage, swelling, or leakage. If such items are sent, they will be disposed of.
2. If the customer provides an incorrect shipping address or refuses to accept delivery, they will be responsible for any resulting losses.
3. Water damage significantly impacts product performance, and such products are not repairable. We will offer a replacement product instead.
4. Before sending a product for repair, please remove any personalized items or decorations (e.g., stickers, paint). Reebot Robotics will not be responsible for the loss or damage of such items.

REEBOT

5. Please inspect the product for damage upon receipt. If there is any damage, notify us within 7 days of receipt. For damages caused during shipping, notify us within 24 hours for claims.

This after-sales policy takes effect from the date of release. The company reserves the right of final interpretation, and all related matters shall be governed by this policy.